



24
25

CABLE PROTECTION DUCTS



You stand for our success

New technologies guarantee the improvement and innovation of our products. For you.

KOPOS KOLÍN a.s. is a leading manufacturer of wiring material with over 90 years of tradition. We currently produce over 5 000 products. The plastic category includes wiring boxes, mini trunkings, parapet (wall) trunkings, rigid or flexible pipes, double wall protector conduits (registered bussiness mark KOPOFLEX® and KOPODUR® system), divided cable duct KOPOHALF®.

We also produce cable management systems such as cable trays, MARS, cable trays, JUPITER®, wire trays or a stainless steel program.

With the increasing demands on safety of buildings, we have expanded and introduced systems to maintain functionality in the fire. Choose from a variety of carefully tested systems.

The company considers it natural to produce products from halogen-free materials. By replacing lead in plastic mixtures and other environmental activities, we don't want to stand out in the environmental protection.

The products comply with the requirements of the European standards and are tested in the electrotechnical institutes. The company also owns a production technology used for the production of NEUTROSTOP shieldings. Their use is important especially on places where it is necessary to protect the environment from the neutron radiation.

We sell our products around the world through 10 daughter companies. KOPOS KOLÍN a.s. is a holder of certificates according to ISO 9001 and ISO 14001, Czech Quality and Safety Certificate.





Cable protection ducts

Corrugated double-wall cable ducts KOPOFLEX® and KOPODUR®	2
HDPE communication cable ducts	6
Divided cable ducts KOPOHALF®	10
Inground channels KOPOKAN	11
Storage cable ducts	11

Documents for designing plastic cable ducts

Introduction	12
--------------------	----

Flexible corrugated double-wall cable ducts KOPOFLEX®

KF 09040	14
KF 09050	15
KF 09063	16
KF 09075	17
KF 09090	18
KF 09110	19
KF 09125	20
KF 09160	21
KF 09200	22

Rigid corrugated double-wall cable ducts KOPODUR®

KD 09050	23
KD 09063	24
KD 09075	25
KD 09090	26
KD 09110	27
KD 09125	28
KD 09160	29
KD 09200	30

HDPE communication cable ducts

06025	31
06032	32
06040	33
06050	34

Divided cable ducts KOPOHALF®

06110/2	35
06110P/2	36
06160/2	37

Inground channels KOPOKAN

KOPOKAN 1	38
KOPOKAN 2	39
KOPOKAN 3	40
KOPOKAN 4	41

Installation instructions for protective pipes KOPOFLEX® and KOPODUR®

Joining and laying of protective pipes	42
Spacers and plugs	43

Corrugated double-wall cable ducts KOPOFLEX® and KOPODUR®



The duct system KOPOFLEX® and KOPODUR® offers a wide range of applicability. It is particularly suitable for the mechanical protection of all kinds of power and telecommunication cables.

Benefits of double-wall cable ducts compared to other duct types:

Benefits of the materials used:

- polyethylene, the material of the ducts, offers high resistance to aggressive substances
- possible use in the chemical industry
- halogen-free material
- suitable for the protection of water pipes
- different colours
- possible design with high UV stability
- the zero content of asbestos protects human health



Benefits of the unique method of a double-wall ducts production:

- the double wall and the corrugated shape provide high resistance under compression



- possible change of the description on the pipe
- easy handling with the ducts when loading and re-loading



KOPOFLEX® - high flexibility



KOPODUR® - high rigidity



Installation benefits:

- can be installed directly in the soil, with no need of a sand bed



- possible installation directly in concrete
- a slip-over coupling seals the duct joint on IP 40



- sealing rings fitted on both ends of the duct protect the joint against humidity and temporary flooding with water (IP67)



- well-arranged installation in multiple layers and rows thanks to the distance spacers

- broad temperature range for application

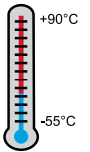

- when installing, it is advisable to use at least 1 empty extra pipe in case that additional cables are needed in future

Benefits for inserting cables:

- the slight wall corrugation allows easy cable insertion and reduces friction by up to 30%
- the smooth inner surface (compared to concrete pipes) eliminates the possibility of cable damage



- a pull-through string ensures easy cable insertion

Piktogramy - legenda

	material		color
	temperature resistance, scope of application (°C)		minimum bending radius (mm)
	fire reaction class of underlying material		package (m; pcs)
	self-extinguishing		package dimensions
	mechanical resistance / load limit value (N)	dn	outside diameter
	level of protection - IP classification	di	minimal inner diameter
	halogen-free material	R	bending radius
	UV stable	L	length
	made of recycled material		



KOPOFLEX®

- flexible doublecoat corrugated pipe



HDPE



operating temperature: -55 - +90°C
installation temperature: -25- +90°C



A1



450 N/20 cm



IP40

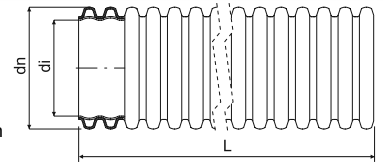

- ▶ Halogen-free flexible double-coated pipe designed for mechanical protection of all kinds of power and data wiring.
- ▶ The pipes are made in compliance with ČSN EN 61386-24.
- ▶ Each coil is equipped with a pull-through string or wire that ensures easy cable insertion and a coupling on one end.
- ▶ When using a sealing ring, the protection class is IP 67.
- ▶ The product may have common surface mechanical damage (crumpling, scratches, deformations of the ribs) to the outer wall of the pipe caused by production or transport technology, which does not affect the functionality of the product.

dn mm	item		di mm		L m			in stock	EAN	
				mm	m	m	cm			pg.
40	KF 09040_AA	orange	32	230	50	3000	64 x 31	☀ - min. 3000 m	8595057619425	
	KF 09040_BA	red			50	3000	64 x 31	●	8595057606333	
	KF 09040_BB	red			25	3000	50 x 27	●	8595568917423	
	KF 09040_CA	blue			50	3000	64 x 31	●	8595057615625	
	KF 09040_CB	blue			25	3000	50 x 27	●	8595057621107	
	KF 09040_DA	green			50	3000	64 x 31	☀ - min. 3000 m	8595057619432	
	KF 09040_EA	yellow			50	3000	64 x 31	☀ - min. 3000 m	8595057608641	
	KF 09040_FA	black			50	3000	64 x 31	●	8595057616226	
50	KF 09050_BA	red	41	350	50	1800	77 x 33	●	8595057606340	
	KF 09050_BB	red			25	1500	60 x 33	●	8595568917430	
	KF 09050_CA	blue			50	1800	77 x 33	●	8595057655935	
	KF 09050_CB	blue			25	1500	60 x 33	●	8595057655928	
	KF 09050_EA	yellow			50	1800	77 x 33	☀ - min. 1800 m	8595057606357	
	KF 09050_FA	black			50	1800	77 x 33	●	8595057616233	
63	KF 09063_BA	red	52	350	50	1500	80 x 46	●	8595057643703	
	KF 09063_BB	red			25	1050	70 x 35	●	8595568936431	
	KF 09063_CA	blue			50	1500	80 x 46	●	8595057644977	
	KF 09063_FA	black			50	1500	80 x 46	●	8595057650527	
	KF 09075_BA	red			61	350	50	-	94 x 50	
KF 09075_BB	red	25	900	81 x 38			●	8595568936448		
KF 09075_CA	blue	50	-	94 x 50			●	8595057644991		
KF 09075_CB	blue	25	900	81 x 38			●	8595057645004		
KF 09075_FA	black	50	-	94 x 50			●	8595057650534		
90	KF 09090_AA	orange	75	400	50	-	113 x 50	☀ - min. 1000 m	8595568918796	
	KF 09090_BA	red			50	-	113 x 50	●	8595057643727	
	KF 09090_BB	red			25	400	98 x 39	●	8595568936455	
	KF 09090_CA	blue			50	-	113 x 50	●	8595057650435	
	KF 09090_FA	black			50	-	113 x 50	●	8595057650442	
110	KF 09110_BA	red	94	400	50	-	124 x 60	●	8595057606364	
	KF 09110_BB	red			25	-	100 x 46	●	8595057692824	
	KF 09110_CA	blue			50	-	124 x 60	●	8595057615649	
	KF 09110_CB	blue			25	-	100 x 46	●	8595057655911	
	KF 09110_FA	black			50	-	124 x 60	●	8595057616240	
125	KF 09125_BA	red	108	500	50	-	135 x 62	●	8595057618336	
	KF 09125_BB	red			25	-	109 X 50	●	8595568937681	
	KF 09125_CA	blue			50	-	135 x 62	●	8595568937698	
	KF 09125_CB	blue			25	-	109 X 50	●	8595568937704	
	KF 09125_FA	black			50	-	135 x 62	●	8595568937407	
160	KF 09160_BA	red	136	650	50	-	194 x 58	●	8595057643741	
	KF 09160_BB	red			25	-	128 x 58	●	8595057647800	
	KF 09160_CB	blue			25	-	128 x 58	●	8595057647794	
	KF 09160_FA	black			50	-	194 x 58	●	8595057650565	
200	KF 09200_BB	red	176	850	25	-	160 x 60	●	8595568903587	
	KF 09200_FB	black			25	-	160 x 60	●	8595057688568	

5

KOPOFLEX®

- UV stable flexible doublecoat corrugated pipe

 HDPE operating temperature: -55 - +90°C
 installation temperature: -25- +90°C

A1

450 N/20 cm

IP40

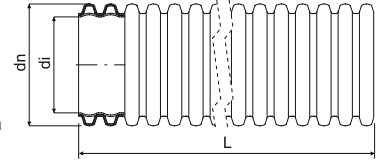

- ▶ Halogen-free flexible double-coated pipe designed for mechanical protection of all kinds of power and data wiring.
- ▶ The pipes are made in compliance with ČSN EN 61386-24.
- ▶ Each coil is equipped with a pull-through string or wire that ensures easy cable insertion and a coupling on one end.
- ▶ When using a sealing ring, the protection class is IP 67.
- ▶ The product may have common surface mechanical damage (crumpling, scratches, deformations of the ribs) to the outer wall of the pipe caused by production or transport technology, which does not affect the functionality of the product.



dn	item		di		L			in stock	EAN	
mm			mm	mm	m	m	cm			pg.
40	KF 09040_UVFA	black	32	230	50	3000	64 x 31	●	8595057698147	5
50	KF 09050_UVFA	black	41	350	50	1800	77 x 33	●	8595057698178	
63	KF 09063_UVFA	black	52	350	50	1500	80 x 46	●	8595057698208	
75	KF 09075_UVFA	black	61	350	50	-	94 x 50	●	8595057698338	
90	KF 09090_UVFA	black	75	400	50	-	113 x 50	●	8595057698239	
110	KF 09110_UVFA	black	94	400	50	-	124 x 60	●	8595057698260	
125	KF 09125_UVFA	black	108	500	50	-	135 x 62	●	8595568937414	
160	KF 09160_UVFA	black	136	650	50	-	194 x 58	●	8595057698369	
200	KF 09200_UVFB	black	176	850	25	-	190 x 70	●	8595568940742	

KOPODUR®

- rigid doublecoat corrugated pipe

 HDPE operating temperature: -55 - +90°C
 installation temperature: -25- +90°C

A1

450 N/20 cm

IP40

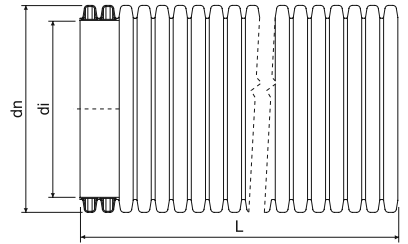

- ▶ Halogen-free rigid double-coated pipe designed for mechanical protection of all kinds of power and data wiring.
- ▶ The pipes are made in compliance with ČSN EN 61386-24.
- ▶ The pipe is available in form of a bar, the coupling is put on one end of it.
- ▶ The connection is sealed dust/sand resistant.
- ▶ When using a sealing ring, the protection class is IP 67.
- ▶ The product may have common surface mechanical damage (crumpling, scratches, deformations of the ribs) to the outer wall of the pipe caused by production or transport technology, which does not affect the functionality of the product.



dn	item		di	L			in stock	EAN
mm			mm	m	m	cm		
40	KD 09040_BC	red	32	6	432	45 x 45 x 605	⌚ - min. 1296 m	8595057643758
50	KD 09050_BC	red	41	6	360	82 x 66 x 605	●	8595057643765
	KD 09050_CC	blue		6	360		●	8595057650459
	KD 09050_FC	black		6	360		●	8595057689404
63	KD 09063_BC	red	52	6	312	80 x 52 x 605	●	8595057643772
75	KD 09075_BC	red	61	6	312	104 x 88 x 607	●	8595057643789
	KD 09075_CC	blue		6	312		●	8595057650121
90	KD 09090_BC	red	75	6	312	120 x 76 x 607	●	8595057643796
110	KD 09110_BC	red	94	6	462	112 x 95 x 610	●	8595057606449
	KD 09110_CC	blue		6	216		77 x 64 x 610	●
125	KD 09125_BC	red	108	6	318	129 x 90 x 610	●	8595057618299
160	KD 09160_BC	red	136	6	198	120 x 72 x 610	●	8595057643819
	KD 09160_CC	blue		6	198		●	8595057647848
	KD 09160_FC	black		6	198		⌚	8595057651418
200	KD 09200_BC	red	176	6	120	122 x 74 x 615	●	8595057618312
	KD 09200_FC	black		6	162		⌚	8595057684041



Accessories for corrugated pipes KOPOFLEX® and KOPODUR®



-45 - +60°C

- Couplings** - slip-over couplings are the same for both types of pipes and are used to join the pipes.
- Sealing rings** - the same for both types of pipes and are used to seal the joint to prevent it against humidity and water.
- Closing plugs** - for blinding of backup lines and for temporary blinding of pipes when installing.
- Distance spacers** - for position fixation of several pipes in one excavation.
Distance spacers serve for fixation 8 pipes and spacer can be split for fixation 2, 4 and 6 pipes. Per order only.

pipe dn mm	Couplings		Sealing rings		Closing plugs		Distance spacers	
	item	EAN	item	EAN	item	EAN	item	EAN
40	02040_FA	8595057612082	16040_FB	8595057606609	17040_BB	8595057606661	-	-
50	02050_FA	8595057613249	16050_FB	8595057606616	17050_BB	8595057606678	07050/8_FB	8595057615113
63	02063_FA	8595057650466	16063_FB	8595057606623	17063_BB	8595057606685	07063/8_FB	8595057626225
75	02075_FA	8595057650473	16075_FB	8595057606630	17075_BB	8595057606692	07075/8_FB	8595057622111
90	02090_FA	8595057650480	16090_FB	8595057609167	17090_BB	8595057609204	07090/8_FB	8595057658035
110	02110_FA	8595057612075	16110_FB	8595057606647	17110_BB	8595057606708	07110/8_FB	8595057610538
125	02125_FA	8595568938596	-	-	17125_BB	8595057606715	07125/8_FB	8595057635036
160	02160_FA	8595057650497	16160_FB	8595057609044	17160_BB	8595057609228	07160/8_FB	8595057635050
200	02200_FB	8595057617438	-	-	17200_BB	8595057610798	07200/8_FB	8595057658059

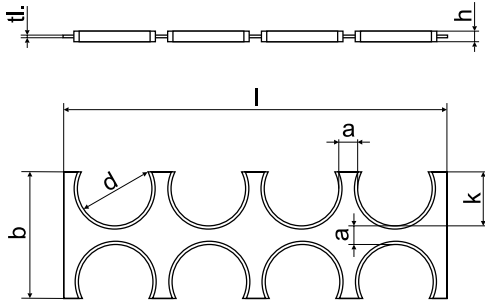

distance spacer	distance	height	fixing width	fixing height	material thickness	total width	total width after opening			
	a	b	h	k	tl.	l (8x)	l (2x)	l (4x)	l (6x)	
07050/8	30	97	12	34	2,5	328	80	160	240	
07063/8	30	116	12	43	2,5	381	95	190	280	
07075/8	25	125	12	50	2,5	408	105	208	305	
07090/8	28	148	14	60	2,5	482	125	247	360	
07110/8	30	190	15	80	3	568	142	284	426	
07125/8	38	210	20	88	3	658	175	336	497	
07160/8	60	270	25	107	5	885	225	450	665	
07200/8	80	345	25	133	5	1135	287	575	847	

HDPE communication cable ducts

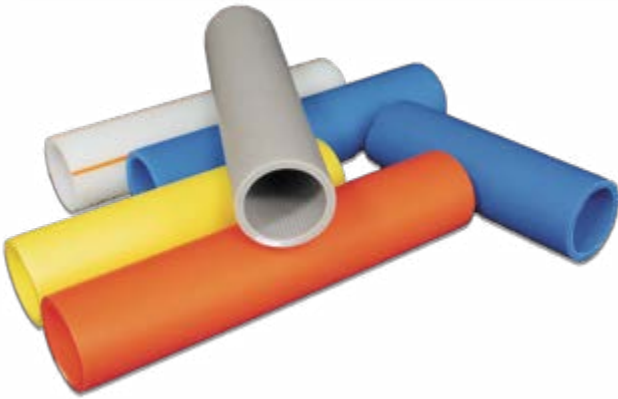

Single-wall protection ducts for fibre-optic and metallic cables.

As requested by the customer:

Colour strips facilitate cable identification when several protection ducts are installed in a single excavation.

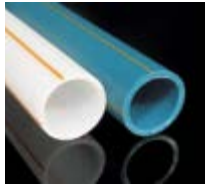

► The shape of longitudinal grooves ensures easier air-blown installation of cables.

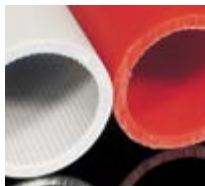

► The ducts can be provided with some text (including length indications).



► The ducts are supplied in harnesses 100 m or 300 m long.

To create a line, it is possible to connect the individual harnesses with couplings.

For larger line sections, a 1750 m package is also available (for the dimension 06050 - 1250 m), supplied on wooden drums.



KOPOS KOLÍN a.s. supplies fibre-optic cable ducts even in large harnesses of 2000 m (06040) and 1250 m (06050) for installation on unwinding metal drums.

When the drum side plate is removed, the coil is slid onto the drum, the side plate is replaced and the drum is ready for unwinding.

The advantage of this solution consists in cost savings thanks to the transport of a larger quantity of wooden drums.



The air-blown installation technology allows the installation of fibre-optic cables with an outer diameter of 6,5 to 32 mm in suitable protective pipes made of polyethylene by means of a large air mass.

Thanks to the generated laminar air flow in the duct and the additional mechanical cable drift inside the duct, the fibre-optic cable is carried and moved forward.

With a good technological procedure, it is possible to air-blow very long fibre-optic cables in ducts, even exceeding 2000 m. A huge advantage of this method is a very careful installation of the cables - without any pulling force. KOPOS KOLÍN a.s. does not install the ducts; please contact a provider of such services who possesses the necessary technology for duct installation and cable airblowing.





Optical cable protectors HDPE

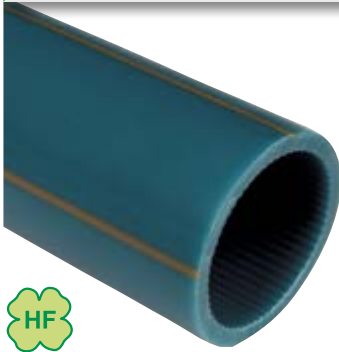

HDPE
 -5 - +50°C
 A1
 750 N/20 cm

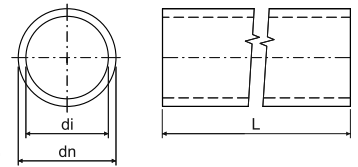

- ▶ Single-coated pipes designed to protect cables with optical fibers under the ground.
- ▶ For larger volumes different color versions (beyond presented versions), labeling, number of distinctive stripes, denticular inner surface or inner diameter size (material thickness) can be ordered based on customer needs and specifications.
- ▶ Shock resistance: N (normal, ČSN EN 61386-24)
- ▶ Bend resistance: flexible
- ▶ The protectors are tested under pressure of 1,5 MPa for the time of 1 hour.
- ▶ The packaging on wooden drums and pallets for unwinding drums is delivered just upon previous order according to the customers's specification.

dn	item	description		di	L		in stock	EAN	
mm				mm	m	mm			pg.
25	06025_FS100	harness	black	20	100	400	☺ - min. 1200 m	8595568903730	8-9
	06025_KS100	harness	light grey				☺ - min. 1200 m	8595568903860	
32	06032_AS100	harness	orange	27	100	400	●	8595057657328	
	06032_BS100	harness	red		100		●	8595057656390	
	06032_ES100	harness	yellow		100		●	8595057656413	
	06032_FB	drum	black		1750		☺ - min. 1750 m	8595568915573	
	06032_FS100	harness	black		100		●	8595057665552	
	06032_LS100	harness	dark grey		100		●	8595057665569	
40	06040_AB	drum	orange	33	1750	400	☺ - min. 1750 m	8595057655393	
	06040_AP	harness - pallet	orange		2000		☺ - min. 2000 m	8595057658226	
	06040_AS100	harness	orange		100		●	8595057655409	
	06040_AS300	harness	orange		300		●	8595568919540	
	06040_BB	drum	red		1750		☺ - min. 1750 m	8595057655416	
	06040_BS100	harness	red		100		●	8595057655423	
	06040_BS300	harness	red		300		☺ - min. 1800 m	8595568903303	
	06040_CB	drum	blue		1750		☺ - min. 1750 m	8595057655430	
	06040_CS100	harness	blue		100		●	8595057655447	
	06040_CS300	harness	blue		300		●	8595568903457	
	06040_DS100	harness	green		100		☺ - min. 1600 m	8595057655461	
	06040_EB	drum	yellow		1750		☺ - min. 1750 m	8595057655478	
	06040_ES100	harness	yellow		100		●	8595057655485	
	06040_ES300	harness	yellow		300		☺ - min. 1800 m	8595568903716	
	06040_FB	drum	black		1750		☺ - min. 1750 m	8595057655492	
	06040_FS100	harness	black		100		●	8595057655508	
	06040_KS100	harness	light grey		100		●	8595057655546	
	06040_KS1VO	harness	light grey		100		●	8595568927286	
06040_LB	drum	dark grey	1750	☺ - min. 1750 m	8595057655553				
50	06050_AB	drum	orange	44	1250	500	☺ - min. 1250 m	8595057657298	
	06050_AS100	harness	orange		100		●	8595057657304	
	06050_BS100	harness	red		100		●	8595057699540	
	06050_CP	harness - pallet	blue		1250		min. 1250 m	8595057689411	
	06050_CS100	harness	blue		100		●	8595057691070	
	06050_FB	drum	black		1250		min. 1250 m	8595568912558	
	06050_FS100	harness	black		100		●	8595057665576	

Optical cable protectors from recycled HDPE

MAT			
HDPE	-5 - +50°C	A1	750 N/20 cm

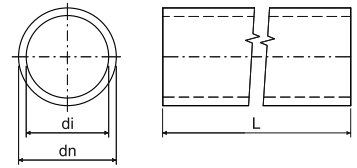

- ▶ Single-coated pipes designed to protect cables with optical fibers under the ground.
- ▶ Inner material - recycled HDPE.
- ▶ For larger volumes different color versions (beyond presented versions), labeling, number of distinctive stripes.
- ▶ Shock resistance: N (normal, ČSN EN 61386-24)
- ▶ Bend resistance: flexible
- ▶ The protectors are tested under pressure of 1,5 MPa for the time of 1 hour.
- ▶ The packaging on wooden drums and pallets for unwinding drums is delivered just upon previous order according to the customer's specification.

dn mm	item	description		di mm	L m		in stock	EAN	
						mm			pg.
40	06040_ARGB	drum	orange/black	33	1750	400	⊕ - min. 1750 m	8595568930880	8-9
	06040_ARGS1	harness	orange/black		100		•	8595568930897	
	06040_CRGS1	harness	blue/black		100		•	8595568932457	

Screw connectors for optical cable protectors

MAT		
PP	-5 - +50°C	A1

- ▶ The connector is designed to join HDPE optic cable protector when routing and ensures a perfect connection.
- ▶ PN16 pressure line.

pipe dn mm	item			EAN
			pcs	
25	05025_KB	grey	1	8595568905451
32	05030_KB	grey	1	8595057657335
40	05040_KB	grey	1	8595057606821
50	05050_KB	grey	1	8595057651579

Push connectors for optical cable protectors

MAT		
PP	-5 - +50°C	A1

- ▶ The connector is designed to join HDPE optic cable protector when routing and ensures a perfect connection.
- ▶ The pipe is pushed onto the connector.
- ▶ PN16 pressure line.

pipe dn mm	item			EAN
			pcs	
32	05033_KB	grey	1	8595057657694
40	05043_KB	grey	1	8595057657700
50	05053_KB	grey	1	8595057657717





Fittings for optical cable protectors



PP -5 - +50°C A1

- ▶ The fitting is used to end the routing.
- ▶ PN16 pressure line.

pipe dn mm	item	 color	 pcs	EAN
25	05024_KB	grey	1	8595568905468
32	05031_KB	grey	1	8595057657342
40	05041_KB	grey	1	8595057629271
50	05051_KB	grey	1	8595057651586

KOPOHALF®

- divided cable duct



HDPE

 operating temperature: -55 - +90°C
 installation temperature: -25- +90°C

A1

 06110/2 - 450 N/20 cm
 06160/2 - 750 N/20 cm

IP30

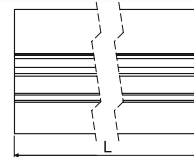
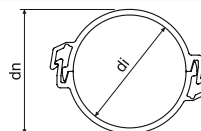

- ▶ A system of divided cable ducts is suitable mainly for a protection of underground cable laying and for a laying-out of the energy and communication lines.
- ▶ Another possible application is a protection of already installed underground cables.
- ▶ The protectors consist of two identical parts.
- ▶ When installing, the cables are put in the bottom part and then the top part is snapped onto the bottom one.
- ▶ Connecting of protectors is performed by overlapping joined lower parts with an upper part at length of approximately 30 cm.
- ▶ The divided cable ducts are manufactured and tested in accordance with standard ČSN EN 61386-24.

dn mm	item	description		di min. mm	L m		EAN
110	06110/2_BA	in distributed position	red	97	3	162	8595057651814
	06110/2_CA	in distributed position	blue		3	162	8595057651821
	06110/2_FA	in distributed position	black		3	162	8595057688506
160	06160/2_BA	in distributed position	red	136	3	72	8595057651791
	06160/2_CA	in distributed position	blue		3	72	8595057651807
	06160/2_EA	in distributed position	yellow		3	min. 72	8595057695931

KOPOHALF®

- divided cable duct made of recycled HDPE



HDPE

 operating temperature: -55 - +90°C
 installation temperature: -25- +90°C



A1



450 N/20 cm

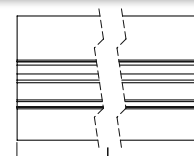

IP30



- ▶ A system of divided cable ducts is suitable mainly for a protection of underground cable laying and for a laying-out of the energy and communication lines.
- ▶ Inner material - recycled HDPE.
- ▶ Another possible application is a protection of already installed underground cables.
- ▶ The protectors consist of two identical parts.
- ▶ When installing, the cables are put in the bottom part and then the top part is snapped onto the bottom one.
- ▶ Connecting of protectors is performed by overlapping joined lower parts with an upper part at length of approximately 30 cm.
- ▶ The divided cable ducts are manufactured and tested in accordance with standard ČSN EN 61386-24.

dn mm	item	description		di min. mm	L m		EAN
110	06110/2_BRGA	in distributed position	red	100	3	162	8595568936905
	06110/2_CRGA	in distributed position	blue		3	162	8595568936912

KOPOHALF®

- divided cable duct



PVC

 storage: -25- +60°C
 montage: -5 - +60°C

A1 - F



30 sec.



750 N/20 cm



IP30

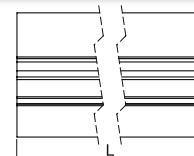
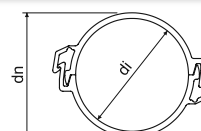

- ▶ A system of divided cable ducts is suitable mainly for a protection of underground cable laying and for a laying-out of the energy and communication lines.
- ▶ Another possible application is a protection of already installed underground cables.
- ▶ The protectors consist of two identical parts.
- ▶ When installing, the cables are put in the bottom part and then the top part is snapped onto the bottom one.
- ▶ Connecting of protectors is performed by overlapping joined lower parts with an upper part at length of approximately 30 cm.
- ▶ The divided cable ducts are manufactured and tested in accordance with standard ČSN EN 61386-24.

dn mm	item	description		di min. mm	L m		EAN
110	06110P/2_BA	in distributed position	red	97	3	162	8595568922007
	06110P/2_CA	in distributed position	blue		3	162	8595568922021
	06110P/2_EA	in distributed position	yellow		3	min. 162	8595568926890
	06110P/2_FA	in distributed position	black		3	min. 162	8595568928634



KOPOKAN - inground channel



MAT
 PVC -5 - +60°C A1 - F 30 sec. IP30

- ▶ Inground channels are intended for mechanical protection of installation of engineering networks to be loaded under the ground.
- ▶ By its technical parameters those fully replace the earlier used concrete channels.
- ▶ It is possible to use them for an additional protection of already installed inground engineering networks.
- ▶ Floor trunkings are supplied with a colour lid.
- ▶ Connected using connectors and folding the lid over, thus interconnecting the individual parts.
- ▶ Strength limit on compression tested on length 300 mm.
- ▶ Inground channels are manufactured according to ČSN EN 61386-1 and ČSN EN 61386-24.

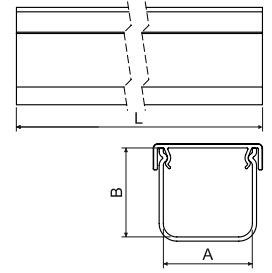

item		A	B	L			EAN
		mm	mm	m	m	N/20 cm	
KOPOKAN 1_CD	grey body / blue lid	100	100	2	140	750	8595568915474
KOPOKAN 1_ZD	grey body / red lid			2			8595568905116
KOPOKAN 2_CD	grey body / blue lid	120	100	2	162	750	8595568926975
KOPOKAN 2_ZD	grey body / red lid			2			8595568905123
KOPOKAN 3_ZD	grey body / red lid	130	140	2	96	750	8595568905130
KOPOKAN 4_CD	grey body / blue lid	200	125	2	70	250	8595568922205
KOPOKAN 4_ZD	grey body / red lid			2			8595568905147

connection for KOPOKAN

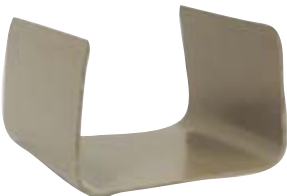

MAT
 PVC -5 - +60°C A1 - F 30 sec.

- ▶ Connector is used to connect the ground channels.
- ▶ It provides a straight direction.

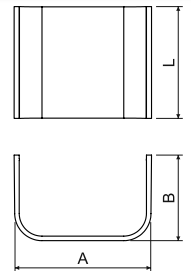

item	description	A	B	L		EAN
		mm	mm	mm	pcs	
SPOJKA K1_ZB	for channel KOPOKAN 1	111	75	100	1	8595568905154
SPOJKA K2_ZB	for channel KOPOKAN 2	137	77	125	1	8595568905161
SPOJKA K3_ZB	for channel KOPOKAN 3	149	75	130	1	8595568905178
SPOJKA K4_ZB	for channel KOPOKAN 4	217	75	125	1	8595568905185

Storage cable ducts

UV-stable corrugated protection ducts KOPOFLEX® can be stored on open, hardened surfaces.
 Other cable ducts (KOPOFLEX®, KOPODUR®, fibre-optic cable ducts HDPE, KOPOHALF® and KOPOKAN) can be stored on open, hardened surfaces, but have to be protected against the long-term effects of the sunlight.
 All duct accessories are to be stored in covered halls.

Manufacturer: EGÚ Brno, a. s.
Electrical Network Department

Client: KOPOS KOLÍN a.s.,
Havlíčková 432, 280 94 Kolín IV

Manufacturer's contract number: 12 002
Client's contract number: Order 120111

DOCUMENTS FOR DESIGNING PLASTIC CABLE DUCTS

Prepared by: Ing. Petr Lehký
Helena Kváčová

Head of Department: Ing. Petr Lehký

Director: Ing. Zdeněk Špaček, CSc.



INTRODUCTION

Maximum load value determined in the document for the projection of plastic cable ducts is based on "Dimensioning Cable Ducts" methodology that has been prepared for the sphere of power engineering.

Following tables specify the total load values for individual types of surface loading, including the influence of dynamic effects and the load resulting from the soil weight.

The cases of exceeding the permissible load (for the assortment of cable ducts offered) are printed in bold and shaded.

The load capacity of cable ducts has been determined with regard to max. 5% deformation. Cable ducts passing through a track bed may not be deformed by more than 3%. It implies that the load may not exceed the value of permissible stress at the deformation of 3 %.

The permissible load on cable ducts has been determined based on their ring stiffness set in accordance with ČSN EN ISO 9969.

- Road Transport Class A: 240 kN (120 kN per wheel)
 - Road Transport Class B: 165 kN (82,5 kN per wheel)
 - Tram Transport: 120 kN (60 kN per wheel)
 - UIC 71 - Single and Double Track: 250 kN (125 kN per wheel)
 - Entrances 40 kN (20 kN per wheel)
-

KF 09040

- flexible corrugated double-wall cable ducts KOPOFLEX®

Ring stiffness in accordance with ČSN EN ISO 9969 S = 20,9 kPa
 Permissible load at the deformation of 3%: Q = 187,0 kPa
 Permissible load at the deformation of 5%: Q = 311,7 kPa

type of load	load by soil weight									
height of protection (m)	0,30	0,40	0,50	0,60	0,70	0,80	0,90	1,00	1,10	
total load (kPa)	8,55	11,40	14,25	17,10	19,95	22,80	25,65	28,50	31,35	
type of load	road load class A									
height of protection (m)	0,30	0,40	0,50	0,60	0,70	0,80	0,90	1,00	1,10	
total load (kPa)	857,6	489,6	315,3	223,6	170,6	138,1	117,1	103,3	93,9	
type of load	road load class B									
height of protection (m)	0,30	0,40	0,50	0,60	0,70	0,80	0,90	1,00	1,10	
total load (kPa)	604,7	340,2	221,2	159,1	123,5	102,0	88,6	79,9	74,4	
type of load	drive load									
height of protection (m)	0,30	0,40	0,50	0,60	0,70	0,80	0,90	1,00	1,10	
total load (kPa)	297,4	170,4	113,8	84,9	68,8	59,6	54,3	51,4	50,1	
type of load	pavement and cycling track load									
height of protection (m)	0,30	0,40	0,50	0,60	0,70	0,80	0,90	1,00	1,10	
total load (kPa)	63,4	42,0	33,7	30,5	29,8	30,3	31,6	33,3	35,4	
type of load	tram load									
height of protection (m)	0,30	0,40	0,50	0,60	0,70	0,80	0,90	1,00	1,10	
total load (kPa)	365,6	211,1	141,8	106,1	86,3	74,9	68,4	64,8	63,1	
type of load	single rail load UIC 71 train									
height of protection (m)	0,8	1,0	1,5	2,0	2,5	3,0	3,5	4,0	4,5	5,0
total load (kPa)	137,0	105,4	85,7	90,2	98,3	107,9	118,4	129,6	141,4	153,7
type of load	double rail load UIC 71 train									
height of protection (m)	0,8	1,0	1,5	2,0	2,5	3,0	3,5	4,0	4,5	5,0
total load (kPa)	137,4	106,2	87,4	93,0	101,9	111,8	122,4	133,5	145,1	157,2

XXXX

Highlighting the cases, when ducts fail to meet the requirements or their use is on the limit of permissible load.

KF 09050

- flexible corrugated double-wall cable ducts KOPOFLEX®

Ring stiffness in accordance with ČSN EN ISO 9969 S = 20,0 kPa

Permissible load at the deformation of 3%: Q = 181,8 kPa

Permissible load at the deformation of 5%: Q = 303,1 kPa

type of load	load by soil weight									
height of protection (m)	0,30	0,40	0,50	0,60	0,70	0,80	0,90	1,00	1,10	
total load (kPa)	8,55	11,40	14,25	17,10	19,95	22,80	25,65	28,50	31,35	
type of load	road load class A									
height of protection (m)	0,30	0,40	0,50	0,60	0,70	0,80	0,90	1,00	1,10	
total load (kPa)	857,6	489,6	315,3	223,6	170,6	138,1	117,1	103,3	93,9	
type of load	road load class B									
height of protection (m)	0,30	0,40	0,50	0,60	0,70	0,80	0,90	1,00	1,10	
total load (kPa)	604,7	340,2	221,2	159,1	123,5	102,0	88,6	79,9	74,4	
type of load	drive load									
height of protection (m)	0,30	0,40	0,50	0,60	0,70	0,80	0,90	1,00	1,10	
total load (kPa)	297,4	170,4	113,8	84,9	68,8	59,6	54,3	51,4	50,1	
type of load	pavement and cycling track load									
height of protection (m)	0,30	0,40	0,50	0,60	0,70	0,80	0,90	1,00	1,10	
total load (kPa)	63,4	42,0	33,7	30,5	29,8	30,3	31,6	33,3	35,4	
type of load	tram load									
height of protection (m)	0,30	0,40	0,50	0,60	0,70	0,80	0,90	1,00	1,10	
total load (kPa)	365,6	211,1	141,8	106,1	86,3	74,9	68,4	64,8	63,1	
type of load	single rail load UIC 71 train									
height of protection (m)	0,8	1,0	1,5	2,0	2,5	3,0	3,5	4,0	4,5	5,0
total load (kPa)	137,0	105,4	85,7	90,2	98,3	107,9	118,4	129,6	141,4	153,7
type of load	double rail load UIC 71 train									
height of protection (m)	0,8	1,0	1,5	2,0	2,5	3,0	3,5	4,0	4,5	5,0
total load (kPa)	137,4	106,2	87,4	93,0	101,9	111,8	122,4	133,5	145,1	157,2

XXXX

Highlighting the cases, when ducts fail to meet the requirements or their use is on the limit of permissible load.

KF 09063

- flexible corrugated double-wall cable ducts KOPOFLEX®

Ring stiffness in accordance with ČSN EN ISO 9969 S = 14,45 kPa

Permissible load at the deformation of 3%: Q = 149,7 kPa

Permissible load at the deformation of 5%: Q = 217,4 kPa

type of load	load by soil weight									
height of protection (m)	0,30	0,40	0,50	0,60	0,70	0,80	0,90	1,00	1,10	
total load (kPa)	8,55	11,40	14,25	17,10	19,95	22,80	25,65	28,50	31,35	
type of load	road load class A									
height of protection (m)	0,30	0,40	0,50	0,60	0,70	0,80	0,90	1,00	1,10	
total load (kPa)	857,6	489,6	315,3	223,6	170,6	138,1	117,1	103,3	93,9	
type of load	road load class B									
height of protection (m)	0,30	0,40	0,50	0,60	0,70	0,80	0,90	1,00	1,10	
total load (kPa)	604,7	340,2	221,2	159,1	123,5	102,0	88,6	79,9	74,4	
type of load	drive load									
height of protection (m)	0,30	0,40	0,50	0,60	0,70	0,80	0,90	1,00	1,10	
total load (kPa)	297,4	170,4	113,8	84,9	68,8	59,6	54,3	51,4	50,1	
type of load	pavement and cycling track load									
height of protection (m)	0,30	0,40	0,50	0,60	0,70	0,80	0,90	1,00	1,10	
total load (kPa)	63,4	42,0	33,7	30,5	29,8	30,3	31,6	33,3	35,4	
type of load	tram load									
height of protection (m)	0,30	0,40	0,50	0,60	0,70	0,80	0,90	1,00	1,10	
total load (kPa)	365,6	211,1	141,8	106,1	86,3	74,9	68,4	64,8	63,1	
type of load	single rail load UIC 71 train									
height of protection (m)	0,8	1,0	1,5	2,0	2,5	3,0	3,5	4,0	4,5	5,0
total load (kPa)	137,0	105,4	85,7	90,2	98,3	107,9	118,4	129,6	141,4	153,7
type of load	double rail load UIC 71 train									
height of protection (m)	0,8	1,0	1,5	2,0	2,5	3,0	3,5	4,0	4,5	5,0
total load (kPa)	137,4	106,2	87,4	93,0	101,9	111,8	122,4	133,5	145,1	157,2

XXXX

Highlighting the cases, when ducts fail to meet the requirements or their use is on the limit of permissible load.

KF 09075

- flexible corrugated double-wall cable ducts KOPOFLEX®

Ring stiffness in accordance with ČSN EN ISO 9969 S = 11,98 kPa

Permissible load at the deformation of 3%: Q = 135,4 kPa

Permissible load at the deformation of 5%: Q = 219,5 kPa

type of load	load by soil weight									
height of protection (m)	0,30	0,40	0,50	0,60	0,70	0,80	0,90	1,00	1,10	
total load (kPa)	8,55	11,40	14,25	17,10	19,95	22,80	25,65	28,50	31,35	
type of load	road load class A									
height of protection (m)	0,30	0,40	0,50	0,60	0,70	0,80	0,90	1,00	1,10	
total load (kPa)	857,6	489,6	315,3	223,6	170,6	138,1	117,1	103,3	93,9	
type of load	road load class B									
height of protection (m)	0,30	0,40	0,50	0,60	0,70	0,80	0,90	1,00	1,10	
total load (kPa)	604,7	340,2	221,2	159,1	123,5	102,0	88,6	79,9	74,4	
type of load	drive load									
height of protection (m)	0,30	0,40	0,50	0,60	0,70	0,80	0,90	1,00	1,10	
total load (kPa)	297,4	170,4	113,8	84,9	68,8	59,6	54,3	51,4	50,1	
type of load	pavement and cycling track load									
height of protection (m)	0,30	0,40	0,50	0,60	0,70	0,80	0,90	1,00	1,10	
total load (kPa)	63,4	42,0	33,7	30,5	29,8	30,3	31,6	33,3	35,4	
type of load	tram load									
height of protection (m)	0,30	0,40	0,50	0,60	0,70	0,80	0,90	1,00	1,10	
total load (kPa)	365,6	211,1	141,8	106,1	86,3	74,9	68,4	64,8	63,1	
type of load	single rail load UIC 71 train									
height of protection (m)	0,8	1,0	1,5	2,0	2,5	3,0	3,5	4,0	4,5	5,0
total load (kPa)	137,0	105,4	85,7	90,2	98,3	107,9	118,4	129,6	141,4	153,7
type of load	double rail load UIC 71 train									
height of protection (m)	0,8	1,0	1,5	2,0	2,5	3,0	3,5	4,0	4,5	5,0
total load (kPa)	137,4	106,2	87,4	93,0	101,9	111,8	122,4	133,5	145,1	157,2

XXXX

Highlighting the cases, when ducts fail to meet the requirements or their use is on the limit of permissible load.

KF 09090

- flexible corrugated double-wall cable ducts KOPOFLEX®

Ring stiffness in accordance with ČSN EN ISO 9969 S = 8,9 kPa
 Permissible load at the deformation of 3%: Q = 117,6 kPa
 Permissible load at the deformation of 5%: Q = 185,1 kPa

type of load	load by soil weight									
height of protection (m)	0,30	0,40	0,50	0,60	0,70	0,80	0,90	1,00	1,10	
total load (kPa)	8,55	11,40	14,25	17,10	19,95	22,80	25,65	28,50	31,35	
type of load	road load class A									
height of protection (m)	0,30	0,40	0,50	0,60	0,70	0,80	0,90	1,00	1,10	
total load (kPa)	857,6	489,6	315,3	223,6	170,6	138,1	117,1	103,3	93,9	
type of load	road load class B									
height of protection (m)	0,30	0,40	0,50	0,60	0,70	0,80	0,90	1,00	1,10	
total load (kPa)	604,7	340,2	221,2	159,1	123,5	102,0	88,6	79,9	74,4	
type of load	drive load									
height of protection (m)	0,30	0,40	0,50	0,60	0,70	0,80	0,90	1,00	1,10	
total load (kPa)	297,4	170,4	113,8	84,9	68,8	59,6	54,3	51,4	50,1	
type of load	pavement and cycling track load									
height of protection (m)	0,30	0,40	0,50	0,60	0,70	0,80	0,90	1,00	1,10	
total load (kPa)	63,4	42,0	33,7	30,5	29,8	30,3	31,6	33,3	35,4	
type of load	tram load									
height of protection (m)	0,30	0,40	0,50	0,60	0,70	0,80	0,90	1,00	1,10	
total load (kPa)	365,6	211,1	141,8	106,1	86,3	74,9	68,4	64,8	63,1	
type of load	single rail load UIC 71 train									
height of protection (m)	0,8	1,0	1,5	2,0	2,5	3,0	3,5	4,0	4,5	5,0
total load (kPa)	137,0	105,4	85,7	90,2	98,3	107,9	118,4	129,6	141,4	153,7
type of load	double rail load UIC 71 train									
height of protection (m)	0,8	1,0	1,5	2,0	2,5	3,0	3,5	4,0	4,5	5,0
total load (kPa)	137,4	106,2	87,4	93,0	101,9	111,8	122,4	133,5	145,1	157,2

XXXX

Highlighting the cases, when ducts fail to meet the requirements or their use is on the limit of permissible load.

KF 09110

- flexible corrugated double-wall cable ducts KOPOFLEX®

Ring stiffness in accordance with ČSN EN ISO 9969 S = 9,97 kPa

Permissible load at the deformation of 3%: Q = 123,8 kPa

Permissible load at the deformation of 5%: Q = 192,9 kPa

type of load	load by soil weight									
height of protection (m)	0,30	0,40	0,50	0,60	0,70	0,80	0,90	1,00	1,10	
total load (kPa)	8,55	11,40	14,25	17,10	19,95	22,80	25,65	28,50	31,35	
type of load	road load class A									
height of protection (m)	0,30	0,40	0,50	0,60	0,70	0,80	0,90	1,00	1,10	
total load (kPa)	857,6	489,6	315,3	223,6	170,6	138,1	117,1	103,3	93,9	
type of load	road load class B									
height of protection (m)	0,30	0,40	0,50	0,60	0,70	0,80	0,90	1,00	1,10	
total load (kPa)	604,7	340,2	221,2	159,1	123,5	102,0	88,6	79,9	74,4	
type of load	drive load									
height of protection (m)	0,30	0,40	0,50	0,60	0,70	0,80	0,90	1,00	1,10	
total load (kPa)	297,4	170,4	113,8	84,9	68,8	59,6	54,3	51,4	50,1	
type of load	pavement and cycling track load									
height of protection (m)	0,30	0,40	0,50	0,60	0,70	0,80	0,90	1,00	1,10	
total load (kPa)	63,4	42,0	33,7	30,5	29,8	30,3	31,6	33,3	35,4	
type of load	tram load									
height of protection (m)	0,30	0,40	0,50	0,60	0,70	0,80	0,90	1,00	1,10	
total load (kPa)	365,6	211,1	141,8	106,1	86,3	74,9	68,4	64,8	63,1	
type of load	single rail load UIC 71 train									
height of protection (m)	0,8	1,0	1,5	2,0	2,5	3,0	3,5	4,0	4,5	5,0
total load (kPa)	137,0	105,4	85,7	90,2	98,3	107,9	118,4	129,6	141,4	153,7
type of load	double rail load UIC 71 train									
height of protection (m)	0,8	1,0	1,5	2,0	2,5	3,0	3,5	4,0	4,5	5,0
total load (kPa)	137,4	106,2	87,4	93,0	101,9	111,8	122,4	133,5	145,1	157,2

XXXX

Highlighting the cases, when ducts fail to meet the requirements or their use is on the limit of permissible load.

KF 09125

- flexible corrugated double-wall cable ducts KOPOFLEX®

Ring stiffness in accordance with ČSN EN ISO 9969 S = 8,4 kPa
 Permissible load at the deformation of 3%: Q = 112,4 kPa
 Permissible load at the deformation of 5%: Q = 180,2 kPa

type of load	load by soil weight									
height of protection (m)	0,30	0,40	0,50	0,60	0,70	0,80	0,90	1,00	1,10	
total load (kPa)	8,55	11,40	14,25	17,10	19,95	22,80	25,65	28,50	31,35	
type of load	road load class A									
height of protection (m)	0,30	0,40	0,50	0,60	0,70	0,80	0,90	1,00	1,10	
total load (kPa)	857,6	489,6	315,3	223,6	170,6	138,1	117,1	103,3	93,9	
type of load	road load class B									
height of protection (m)	0,30	0,40	0,50	0,60	0,70	0,80	0,90	1,00	1,10	
total load (kPa)	604,7	340,2	221,2	159,1	123,5	102,0	88,6	79,9	74,4	
type of load	drive load									
height of protection (m)	0,30	0,40	0,50	0,60	0,70	0,80	0,90	1,00	1,10	
total load (kPa)	297,4	170,4	113,8	84,9	68,8	59,6	54,3	51,4	50,1	
type of load	pavement and cycling track load									
height of protection (m)	0,30	0,40	0,50	0,60	0,70	0,80	0,90	1,00	1,10	
total load (kPa)	63,4	42,0	33,7	30,5	29,8	30,3	31,6	33,3	35,4	
type of load	tram load									
height of protection (m)	0,30	0,40	0,50	0,60	0,70	0,80	0,90	1,00	1,10	
total load (kPa)	365,6	211,1	141,8	106,1	86,3	74,9	68,4	64,8	63,1	
type of load	single rail load UIC 71 train									
height of protection (m)	0,8	1,0	1,5	2,0	2,5	3,0	3,5	4,0	4,5	5,0
total load (kPa)	137,0	105,4	85,7	90,2	98,3	107,9	118,4	129,6	141,4	153,7
type of load	double rail load UIC 71 train									
height of protection (m)	0,8	1,0	1,5	2,0	2,5	3,0	3,5	4,0	4,5	5,0
total load (kPa)	137,4	106,2	87,4	93,0	101,9	111,8	122,4	133,5	145,1	157,2

XXXX

Highlighting the cases, when ducts fail to meet the requirements or their use is on the limit of permissible load.

KF 09160

- flexible corrugated double-wall cable ducts KOPOFLEX®

Ring stiffness in accordance with ČSN EN ISO 9969 S = 6,0 kPa

Permissible load at the deformation of 3%: Q = 100,8 kPa

Permissible load at the deformation of 5%: Q = 160,5 kPa

type of load	load by soil weight									
height of protection (m)	0,30	0,40	0,50	0,60	0,70	0,80	0,90	1,00	1,10	
total load (kPa)	8,55	11,40	14,25	17,10	19,95	22,80	25,65	28,50	31,35	
type of load	road load class A									
height of protection (m)	0,30	0,40	0,50	0,60	0,70	0,80	0,90	1,00	1,10	
total load (kPa)	857,6	489,6	315,3	223,6	170,6	138,1	117,1	103,3	93,9	
type of load	road load class B									
height of protection (m)	0,30	0,40	0,50	0,60	0,70	0,80	0,90	1,00	1,10	
total load (kPa)	604,7	340,2	221,2	159,1	123,5	102,0	88,6	79,9	74,4	
type of load	drive load									
height of protection (m)	0,30	0,40	0,50	0,60	0,70	0,80	0,90	1,00	1,10	
total load (kPa)	297,4	170,4	113,8	84,9	68,8	59,6	54,3	51,4	50,1	
type of load	pavement and cycling track load									
height of protection (m)	0,30	0,40	0,50	0,60	0,70	0,80	0,90	1,00	1,10	
total load (kPa)	63,4	42,0	33,7	30,5	29,8	30,3	31,6	33,3	35,4	
type of load	tram load									
height of protection (m)	0,30	0,40	0,50	0,60	0,70	0,80	0,90	1,00	1,10	
total load (kPa)	365,6	211,1	141,8	106,1	86,3	74,9	68,4	64,8	63,1	
type of load	single rail load UIC 71 train									
height of protection (m)	0,8	1,0	1,5	2,0	2,5	3,0	3,5	4,0	4,5	5,0
total load (kPa)	137,0	105,4	85,7	90,2	98,3	107,9	118,4	129,6	141,4	153,7
type of load	double rail load UIC 71 train									
height of protection (m)	0,8	1,0	1,5	2,0	2,5	3,0	3,5	4,0	4,5	5,0
total load (kPa)	137,4	106,2	87,4	93,0	101,9	111,8	122,4	133,5	145,1	157,2

XXXX

Highlighting the cases, when ducts fail to meet the requirements or their use is on the limit of permissible load.

KF 09200

- flexible corrugated double-wall cable ducts KOPOFLEX®

Ring stiffness in accordance with ČSN EN ISO 9969 S = 6,1 kPa
 Permissible load at the deformation of 3%: Q = 101,7 kPa
 Permissible load at the deformation of 5%: Q = 161,6 kPa

type of load	load by soil weight									
height of protection (m)	0,30	0,40	0,50	0,60	0,70	0,80	0,90	1,00	1,10	
total load (kPa)	8,55	11,40	14,25	17,10	19,95	22,80	25,65	28,50	31,35	
type of load	road load class A									
height of protection (m)	0,30	0,40	0,50	0,60	0,70	0,80	0,90	1,00	1,10	
total load (kPa)	857,6	489,6	315,3	223,6	170,6	138,1	117,1	103,3	93,9	
type of load	road load class B									
height of protection (m)	0,30	0,40	0,50	0,60	0,70	0,80	0,90	1,00	1,10	
total load (kPa)	604,7	340,2	221,2	159,1	123,5	102,0	88,6	79,9	74,4	
type of load	drive load									
height of protection (m)	0,30	0,40	0,50	0,60	0,70	0,80	0,90	1,00	1,10	
total load (kPa)	297,4	170,4	113,8	84,9	68,8	59,6	54,3	51,4	50,1	
type of load	pavement and cycling track load									
height of protection (m)	0,30	0,40	0,50	0,60	0,70	0,80	0,90	1,00	1,10	
total load (kPa)	63,4	42,0	33,7	30,5	29,8	30,3	31,6	33,3	35,4	
type of load	tram load									
height of protection (m)	0,30	0,40	0,50	0,60	0,70	0,80	0,90	1,00	1,10	
total load (kPa)	365,6	211,1	141,8	106,1	86,3	74,9	68,4	64,8	63,1	
type of load	single rail load UIC 71 train									
height of protection (m)	0,8	1,0	1,5	2,0	2,5	3,0	3,5	4,0	4,5	5,0
total load (kPa)	137,0	105,4	85,7	90,2	98,3	107,9	118,4	129,6	141,4	153,7
type of load	double rail load UIC 71 train									
height of protection (m)	0,8	1,0	1,5	2,0	2,5	3,0	3,5	4,0	4,5	5,0
total load (kPa)	137,4	106,2	87,4	93,0	101,9	111,8	122,4	133,5	145,1	157,2

XXXX

Highlighting the cases, when ducts fail to meet the requirements or their use is on the limit of permissible load.



KD 09050

- rigid corrugated double-wall cable ducts KOPODUR®

Ring stiffness in accordance with ČSN EN ISO 9969 S = 27,2 kPa

Permissible load at the deformation of 3%: Q = 223,5 kPa

Permissible load at the deformation of 5%: Q = 372,4 kPa

type of load	load by soil weight									
height of protection (m)	0,30	0,40	0,50	0,60	0,70	0,80	0,90	1,00	1,10	
total load (kPa)	8,55	11,40	14,25	17,10	19,95	22,80	25,65	28,50	31,35	
type of load	road load class A									
height of protection (m)	0,30	0,40	0,50	0,60	0,70	0,80	0,90	1,00	1,10	
total load (kPa)	857,6	489,6	315,3	223,6	170,6	138,1	117,1	103,3	93,9	
type of load	road load class B									
height of protection (m)	0,30	0,40	0,50	0,60	0,70	0,80	0,90	1,00	1,10	
total load (kPa)	604,7	340,2	221,2	159,1	123,5	102,0	88,6	79,9	74,4	
type of load	drive load									
height of protection (m)	0,30	0,40	0,50	0,60	0,70	0,80	0,90	1,00	1,10	
total load (kPa)	297,4	170,4	113,8	84,9	68,8	59,6	54,3	51,4	50,1	
type of load	pavement and cycling track load									
height of protection (m)	0,30	0,40	0,50	0,60	0,70	0,80	0,90	1,00	1,10	
total load (kPa)	63,4	42,0	33,7	30,5	29,8	30,3	31,6	33,3	35,4	
type of load	tram load									
height of protection (m)	0,30	0,40	0,50	0,60	0,70	0,80	0,90	1,00	1,10	
total load (kPa)	365,6	211,1	141,8	106,1	86,3	74,9	68,4	64,8	63,1	
type of load	single rail load UIC 71 train									
height of protection (m)	0,8	1,0	1,5	2,0	2,5	3,0	3,5	4,0	4,5	5,0
total load (kPa)	137,0	105,4	85,7	90,2	98,3	107,9	118,4	129,6	141,4	153,7
type of load	double rail load UIC 71 train									
height of protection (m)	0,8	1,0	1,5	2,0	2,5	3,0	3,5	4,0	4,5	5,0
total load (kPa)	137,4	106,2	87,4	93,0	101,9	111,8	122,4	133,5	145,1	157,2

XXXX

Highlighting the cases, when ducts fail to meet the requirements or their use is on the limit of permissible load.

KD 09063

- rigid corrugated double-wall cable ducts KOPODUR®

Ring stiffness in accordance with ČSN EN ISO 9969 S = 19,33 kPa

Permissible load at the deformation of 3%: Q = 177,9 kPa

Permissible load at the deformation of 5%: Q = 270,24 kPa

type of load	load by soil weight									
height of protection (m)	0,30	0,40	0,50	0,60	0,70	0,80	0,90	1,00	1,10	
total load (kPa)	8,55	11,40	14,25	17,10	19,95	22,80	25,65	28,50	31,35	
type of load	road load class A									
height of protection (m)	0,30	0,40	0,50	0,60	0,70	0,80	0,90	1,00	1,10	
total load (kPa)	857,6	489,6	315,3	223,6	170,6	138,1	117,1	103,3	93,9	
type of load	road load class B									
height of protection (m)	0,30	0,40	0,50	0,60	0,70	0,80	0,90	1,00	1,10	
total load (kPa)	604,7	340,2	221,2	159,1	123,5	102,0	88,6	79,9	74,4	
type of load	drive load									
height of protection (m)	0,30	0,40	0,50	0,60	0,70	0,80	0,90	1,00	1,10	
total load (kPa)	297,4	170,4	113,8	84,9	68,8	59,6	54,3	51,4	50,1	
type of load	pavement and cycling track load									
height of protection (m)	0,30	0,40	0,50	0,60	0,70	0,80	0,90	1,00	1,10	
total load (kPa)	63,4	42,0	33,7	30,5	29,8	30,3	31,6	33,3	35,4	
type of load	tram load									
height of protection (m)	0,30	0,40	0,50	0,60	0,70	0,80	0,90	1,00	1,10	
total load (kPa)	365,6	211,1	141,8	106,1	86,3	74,9	68,4	64,8	63,1	
type of load	single rail load UIC 71 train									
height of protection (m)	0,8	1,0	1,5	2,0	2,5	3,0	3,5	4,0	4,5	5,0
total load (kPa)	137,0	105,4	85,7	90,2	98,3	107,9	118,4	129,6	141,4	153,7
type of load	double rail load UIC 71 train									
height of protection (m)	0,8	1,0	1,5	2,0	2,5	3,0	3,5	4,0	4,5	5,0
total load (kPa)	137,4	106,2	87,4	93,0	101,9	111,8	122,4	133,5	145,1	157,2

XXXX

Highlighting the cases, when ducts fail to meet the requirements or their use is on the limit of permissible load.



KD 09075

- rigid corrugated double-wall cable ducts KOPODUR®

Ring stiffness in accordance with ČSN EN ISO 9969 S = 11,84 kPa

Permissible load at the deformation of 3%: Q = 134,6 kPa

Permissible load at the deformation of 5%: Q = 216,5 kPa

type of load	load by soil weight									
height of protection (m)	0,30	0,40	0,50	0,60	0,70	0,80	0,90	1,00	1,10	
total load (kPa)	8,55	11,40	14,25	17,10	19,95	22,80	25,65	28,50	31,35	
type of load	road load class A									
height of protection (m)	0,30	0,40	0,50	0,60	0,70	0,80	0,90	1,00	1,10	
total load (kPa)	857,6	489,6	315,3	223,6	170,6	138,1	117,1	103,3	93,9	
type of load	road load class B									
height of protection (m)	0,30	0,40	0,50	0,60	0,70	0,80	0,90	1,00	1,10	
total load (kPa)	604,7	340,2	221,2	159,1	123,5	102,0	88,6	79,9	74,4	
type of load	drive load									
height of protection (m)	0,30	0,40	0,50	0,60	0,70	0,80	0,90	1,00	1,10	
total load (kPa)	297,4	170,4	113,8	84,9	68,8	59,6	54,3	51,4	50,1	
type of load	pavement and cycling track load									
height of protection (m)	0,30	0,40	0,50	0,60	0,70	0,80	0,90	1,00	1,10	
total load (kPa)	63,4	42,0	33,7	30,5	29,8	30,3	31,6	33,3	35,4	
type of load	tram load									
height of protection (m)	0,30	0,40	0,50	0,60	0,70	0,80	0,90	1,00	1,10	
total load (kPa)	365,6	211,1	141,8	106,1	86,3	74,9	68,4	64,8	63,1	
type of load	single rail load UIC 71 train									
height of protection (m)	0,8	1,0	1,5	2,0	2,5	3,0	3,5	4,0	4,5	5,0
total load (kPa)	137,0	105,4	85,7	90,2	98,3	107,9	118,4	129,6	141,4	153,7
type of load	double rail load UIC 71 train									
height of protection (m)	0,8	1,0	1,5	2,0	2,5	3,0	3,5	4,0	4,5	5,0
total load (kPa)	137,4	106,2	87,4	93,0	101,9	111,8	122,4	133,5	145,1	157,2

XXXX

Highlighting the cases, when ducts fail to meet the requirements or their use is on the limit of permissible load.

KD 09090

- rigid corrugated double-wall cable ducts KOPODUR®

Ring stiffness in accordance with ČSN EN ISO 9969 S = 8,1 kPa
 Permissible load at the deformation of 3%: Q = 112,9 kPa
 Permissible load at the deformation of 5%: Q = 179,9 kPa

type of load	load by soil weight									
height of protection (m)	0,30	0,40	0,50	0,60	0,70	0,80	0,90	1,00	1,10	
total load (kPa)	8,55	11,40	14,25	17,10	19,95	22,80	25,65	28,50	31,35	
type of load	road load class A									
height of protection (m)	0,30	0,40	0,50	0,60	0,70	0,80	0,90	1,00	1,10	
total load (kPa)	857,6	489,6	315,3	223,6	170,6	138,1	117,1	103,3	93,9	
type of load	road load class B									
height of protection (m)	0,30	0,40	0,50	0,60	0,70	0,80	0,90	1,00	1,10	
total load (kPa)	604,7	340,2	221,2	159,1	123,5	102,0	88,6	79,9	74,4	
type of load	drive load									
height of protection (m)	0,30	0,40	0,50	0,60	0,70	0,80	0,90	1,00	1,10	
total load (kPa)	297,4	170,4	113,8	84,9	68,8	59,6	54,3	51,4	50,1	
type of load	pavement and cycling track load									
height of protection (m)	0,30	0,40	0,50	0,60	0,70	0,80	0,90	1,00	1,10	
total load (kPa)	63,4	42,0	33,7	30,5	29,8	30,3	31,6	33,3	35,4	
type of load	tram load									
height of protection (m)	0,30	0,40	0,50	0,60	0,70	0,80	0,90	1,00	1,10	
total load (kPa)	365,6	211,1	141,8	106,1	86,3	74,9	68,4	64,8	63,1	
type of load	single rail load UIC 71 train									
height of protection (m)	0,8	1,0	1,5	2,0	2,5	3,0	3,5	4,0	4,5	5,0
total load (kPa)	137,0	105,4	85,7	90,2	98,3	107,9	118,4	129,6	141,4	153,7
type of load	double rail load UIC 71 train									
height of protection (m)	0,8	1,0	1,5	2,0	2,5	3,0	3,5	4,0	4,5	5,0
total load (kPa)	137,4	106,2	87,4	93,0	101,9	111,8	122,4	133,5	145,1	157,2

XXXX

Highlighting the cases, when ducts fail to meet the requirements or their use is on the limit of permissible load.



KD 09110

- rigid corrugated double-wall cable ducts KOPODUR®

Ring stiffness in accordance with ČSN EN ISO 9969 S = 9,37 kPa

Permissible load at the deformation of 3%: Q = 120,3 kPa

Permissible load at the deformation of 5%: Q = 195,1 kPa

type of load	load by soil weight									
height of protection (m)	0,30	0,40	0,50	0,60	0,70	0,80	0,90	1,00	1,10	
total load (kPa)	8,55	11,40	14,25	17,10	19,95	22,80	25,65	28,50	31,35	
type of load	road load class A									
height of protection (m)	0,30	0,40	0,50	0,60	0,70	0,80	0,90	1,00	1,10	
total load (kPa)	857,6	489,6	315,3	223,6	170,6	138,1	117,1	103,3	93,9	
type of load	road load class B									
height of protection (m)	0,30	0,40	0,50	0,60	0,70	0,80	0,90	1,00	1,10	
total load (kPa)	604,7	340,2	221,2	159,1	123,5	102,0	88,6	79,9	74,4	
type of load	drive load									
height of protection (m)	0,30	0,40	0,50	0,60	0,70	0,80	0,90	1,00	1,10	
total load (kPa)	297,4	170,4	113,8	84,9	68,8	59,6	54,3	51,4	50,1	
type of load	pavement and cycling track load									
height of protection (m)	0,30	0,40	0,50	0,60	0,70	0,80	0,90	1,00	1,10	
total load (kPa)	63,4	42,0	33,7	30,5	29,8	30,3	31,6	33,3	35,4	
type of load	tram load									
height of protection (m)	0,30	0,40	0,50	0,60	0,70	0,80	0,90	1,00	1,10	
total load (kPa)	365,6	211,1	141,8	106,1	86,3	74,9	68,4	64,8	63,1	
type of load	single rail load UIC 71 train									
height of protection (m)	0,8	1,0	1,5	2,0	2,5	3,0	3,5	4,0	4,5	5,0
total load (kPa)	137,0	105,4	85,7	90,2	98,3	107,9	118,4	129,6	141,4	153,7
type of load	double rail load UIC 71 train									
height of protection (m)	0,8	1,0	1,5	2,0	2,5	3,0	3,5	4,0	4,5	5,0
total load (kPa)	137,4	106,2	87,4	93,0	101,9	111,8	122,4	133,5	145,1	157,2

XXXX

Highlighting the cases, when ducts fail to meet the requirements or their use is on the limit of permissible load.

KD 09125

- rigid corrugated double-wall cable ducts KOPODUR®

Ring stiffness in accordance with ČSN EN ISO 9969 S = 9,4 kPa
 Permissible load at the deformation of 3%: Q = 120,8 kPa
 Permissible load at the deformation of 5%: Q = 195,1 kPa

type of load	load by soil weight									
height of protection (m)	0,30	0,40	0,50	0,60	0,70	0,80	0,90	1,00	1,10	
total load (kPa)	8,55	11,40	14,25	17,10	19,95	22,80	25,65	28,50	31,35	
type of load	road load class A									
height of protection (m)	0,30	0,40	0,50	0,60	0,70	0,80	0,90	1,00	1,10	
total load (kPa)	857,6	489,6	315,3	223,6	170,6	138,1	117,1	103,3	93,9	
type of load	road load class B									
height of protection (m)	0,30	0,40	0,50	0,60	0,70	0,80	0,90	1,00	1,10	
total load (kPa)	604,7	340,2	221,2	159,1	123,5	102,0	88,6	79,9	74,4	
type of load	drive load									
height of protection (m)	0,30	0,40	0,50	0,60	0,70	0,80	0,90	1,00	1,10	
total load (kPa)	297,4	170,4	113,8	84,9	68,8	59,6	54,3	51,4	50,1	
type of load	pavement and cycling track load									
height of protection (m)	0,30	0,40	0,50	0,60	0,70	0,80	0,90	1,00	1,10	
total load (kPa)	63,4	42,0	33,7	30,5	29,8	30,3	31,6	33,3	35,4	
type of load	tram load									
height of protection (m)	0,30	0,40	0,50	0,60	0,70	0,80	0,90	1,00	1,10	
total load (kPa)	365,6	211,1	141,8	106,1	86,3	74,9	68,4	64,8	63,1	
type of load	single rail load UIC 71 train									
height of protection (m)	0,8	1,0	1,5	2,0	2,5	3,0	3,5	4,0	4,5	5,0
total load (kPa)	137,0	105,4	85,7	90,2	98,3	107,9	118,4	129,6	141,4	153,7
type of load	double rail load UIC 71 train									
height of protection (m)	0,8	1,0	1,5	2,0	2,5	3,0	3,5	4,0	4,5	5,0
total load (kPa)	137,4	106,2	87,4	93,0	101,9	111,8	122,4	133,5	145,1	157,2

XXXX

Highlighting the cases, when ducts fail to meet the requirements or their use is on the limit of permissible load.



KD 09160

- rigid corrugated double-wall cable ducts KOPODUR®

Ring stiffness in accordance with ČSN EN ISO 9969 S = 7,2 kPa

Permissible load at the deformation of 3%: Q = 107,8 kPa

Permissible load at the deformation of 5%: Q = 179,6 kPa

type of load	load by soil weight									
height of protection (m)	0,30	0,40	0,50	0,60	0,70	0,80	0,90	1,00	1,10	
total load (kPa)	8,55	11,40	14,25	17,10	19,95	22,80	25,65	28,50	31,35	
type of load	road load class A									
height of protection (m)	0,30	0,40	0,50	0,60	0,70	0,80	0,90	1,00	1,10	
total load (kPa)	857,6	489,6	315,3	223,6	170,6	138,1	117,1	103,3	93,9	
type of load	road load class B									
height of protection (m)	0,30	0,40	0,50	0,60	0,70	0,80	0,90	1,00	1,10	
total load (kPa)	604,7	340,2	221,2	159,1	123,5	102,0	88,6	79,9	74,4	
type of load	drive load									
height of protection (m)	0,30	0,40	0,50	0,60	0,70	0,80	0,90	1,00	1,10	
total load (kPa)	297,4	170,4	113,8	84,9	68,8	59,6	54,3	51,4	50,1	
type of load	pavement and cycling track load									
height of protection (m)	0,30	0,40	0,50	0,60	0,70	0,80	0,90	1,00	1,10	
total load (kPa)	63,4	42,0	33,7	30,5	29,8	30,3	31,6	33,3	35,4	
type of load	tram load									
height of protection (m)	0,30	0,40	0,50	0,60	0,70	0,80	0,90	1,00	1,10	
total load (kPa)	365,6	211,1	141,8	106,1	86,3	74,9	68,4	64,8	63,1	
type of load	single rail load UIC 71 train									
height of protection (m)	0,8	1,0	1,5	2,0	2,5	3,0	3,5	4,0	4,5	5,0
total load (kPa)	137,0	105,4	85,7	90,2	98,3	107,9	118,4	129,6	141,4	153,7
type of load	double rail load UIC 71 train									
height of protection (m)	0,8	1,0	1,5	2,0	2,5	3,0	3,5	4,0	4,5	5,0
total load (kPa)	137,4	106,2	87,4	93,0	101,9	111,8	122,4	133,5	145,1	157,2

XXXX

Highlighting the cases, when ducts fail to meet the requirements or their use is on the limit of permissible load.

KD 09200

- rigid corrugated double-wall cable ducts KOPODUR®

Ring stiffness in accordance with ČSN EN ISO 9969 S = 5,36 kPa

Permissible load at the deformation of 3%: Q = 97,1 kPa

Permissible load at the deformation of 5%: Q = 156,0 kPa

type of load	load by soil weight									
height of protection (m)	0,30	0,40	0,50	0,60	0,70	0,80	0,90	1,00	1,10	
total load (kPa)	8,55	11,40	14,25	17,10	19,95	22,80	25,65	28,50	31,35	
type of load	road load class A									
height of protection (m)	0,30	0,40	0,50	0,60	0,70	0,80	0,90	1,00	1,10	
total load (kPa)	857,6	489,6	315,3	223,6	170,6	138,1	117,1	103,3	93,9	
type of load	road load class B									
height of protection (m)	0,30	0,40	0,50	0,60	0,70	0,80	0,90	1,00	1,10	
total load (kPa)	604,7	340,2	221,2	159,1	123,5	102,0	88,6	79,9	74,4	
type of load	drive load									
height of protection (m)	0,30	0,40	0,50	0,60	0,70	0,80	0,90	1,00	1,10	
total load (kPa)	297,4	170,4	113,8	84,9	68,8	59,6	54,3	51,4	50,1	
type of load	pavement and cycling track load									
height of protection (m)	0,30	0,40	0,50	0,60	0,70	0,80	0,90	1,00	1,10	
total load (kPa)	63,4	42,0	33,7	30,5	29,8	30,3	31,6	33,3	35,4	
type of load	tram load									
height of protection (m)	0,30	0,40	0,50	0,60	0,70	0,80	0,90	1,00	1,10	
total load (kPa)	365,6	211,1	141,8	106,1	86,3	74,9	68,4	64,8	63,1	
type of load	single rail load UIC 71 train									
height of protection (m)	0,8	1,0	1,5	2,0	2,5	3,0	3,5	4,0	4,5	5,0
total load (kPa)	137,0	105,4	85,7	90,2	98,3	107,9	118,4	129,6	141,4	153,7
type of load	double rail load UIC 71 train									
height of protection (m)	0,8	1,0	1,5	2,0	2,5	3,0	3,5	4,0	4,5	5,0
total load (kPa)	137,4	106,2	87,4	93,0	101,9	111,8	122,4	133,5	145,1	157,2

XXXX

Highlighting the cases, when ducts fail to meet the requirements or their use is on the limit of permissible load.



06025

- HDPE communication cable duct

Ring stiffness in accordance with ČSN EN ISO 9969 $S = 140,3 \text{ kPa}$
 Permissible load at the deformation of 3%: $Q = 887,5 \text{ kPa}$
 Permissible load at the deformation of 5%: $Q = 1275,3 \text{ kPa}$

type of load	load by soil weight									
height of protection (m)	0,30	0,40	0,50	0,60	0,70	0,80	0,90	1,00	1,10	
total load (kPa)	8,55	11,40	14,25	17,10	19,95	22,80	25,65	28,50	31,35	
type of load	road load class A									
height of protection (m)	0,30	0,40	0,50	0,60	0,70	0,80	0,90	1,00	1,10	
total load (kPa)	857,6	489,6	315,3	223,6	170,6	138,1	117,1	103,3	93,9	
type of load	road load class B									
height of protection (m)	0,30	0,40	0,50	0,60	0,70	0,80	0,90	1,00	1,10	
total load (kPa)	604,7	340,2	221,2	159,1	123,5	102,0	88,6	79,9	74,4	
type of load	drive load									
height of protection (m)	0,30	0,40	0,50	0,60	0,70	0,80	0,90	1,00	1,10	
total load (kPa)	297,4	170,4	113,8	84,9	68,8	59,6	54,3	51,4	50,1	
type of load	pavement and cycling track load									
height of protection (m)	0,30	0,40	0,50	0,60	0,70	0,80	0,90	1,00	1,10	
total load (kPa)	63,4	42,0	33,7	30,5	29,8	30,3	31,6	33,3	35,4	
type of load	tram load									
height of protection (m)	0,30	0,40	0,50	0,60	0,70	0,80	0,90	1,00	1,10	
total load (kPa)	365,6	211,1	141,8	106,1	86,3	74,9	68,4	64,8	63,1	
type of load	single rail load UIC 71 train									
height of protection (m)	0,8	1,0	1,5	2,0	2,5	3,0	3,5	4,0	4,5	5,0
total load (kPa)	137,0	105,4	85,7	90,2	98,3	107,9	118,4	129,6	141,4	153,7
type of load	double rail load UIC 71 train									
height of protection (m)	0,8	1,0	1,5	2,0	2,5	3,0	3,5	4,0	4,5	5,0
total load (kPa)	137,4	106,2	87,4	93,0	101,9	111,8	122,4	133,5	145,1	157,2

XXXX

Highlighting the cases, when ducts fail to meet the requirements or their use is on the limit of permissible load.

06032

- HDPE communication cable duct

Ring stiffness in accordance with ČSN EN ISO 9969 S = 66,66 kPa

Permissible load at the deformation of 3%: Q = 451,7 kPa

Permissible load at the deformation of 5%: Q = 678,1 kPa

type of load	load by soil weight									
height of protection (m)	0,30	0,40	0,50	0,60	0,70	0,80	0,90	1,00	1,10	
total load (kPa)	8,55	11,40	14,25	17,10	19,95	22,80	25,65	28,50	31,35	
type of load	road load class A									
height of protection (m)	0,30	0,40	0,50	0,60	0,70	0,80	0,90	1,00	1,10	
total load (kPa)	857,6	489,6	315,3	223,6	170,6	138,1	117,1	103,3	93,9	
type of load	road load class B									
height of protection (m)	0,30	0,40	0,50	0,60	0,70	0,80	0,90	1,00	1,10	
total load (kPa)	604,7	340,2	221,2	159,1	123,5	102,0	88,6	79,9	74,4	
type of load	drive load									
height of protection (m)	0,30	0,40	0,50	0,60	0,70	0,80	0,90	1,00	1,10	
total load (kPa)	297,4	170,4	113,8	84,9	68,8	59,6	54,3	51,4	50,1	
type of load	pavement and cycling track load									
height of protection (m)	0,30	0,40	0,50	0,60	0,70	0,80	0,90	1,00	1,10	
total load (kPa)	63,4	42,0	33,7	30,5	29,8	30,3	31,6	33,3	35,4	
type of load	tram load									
height of protection (m)	0,30	0,40	0,50	0,60	0,70	0,80	0,90	1,00	1,10	
total load (kPa)	365,6	211,1	141,8	106,1	86,3	74,9	68,4	64,8	63,1	
type of load	single rail load UIC 71 train									
height of protection (m)	0,8	1,0	1,5	2,0	2,5	3,0	3,5	4,0	4,5	5,0
total load (kPa)	137,0	105,4	85,7	90,2	98,3	107,9	118,4	129,6	141,4	153,7
type of load	double rail load UIC 71 train									
height of protection (m)	0,8	1,0	1,5	2,0	2,5	3,0	3,5	4,0	4,5	5,0
total load (kPa)	137,4	106,2	87,4	93,0	101,9	111,8	122,4	133,5	145,1	157,2

XXXX

Highlighting the cases, when ducts fail to meet the requirements or their use is on the limit of permissible load.



06040

- HDPE communication cable duct

Ring stiffness in accordance with ČSN EN ISO 9969 S = 62,62 kPa

Permissible load at the deformation of 3%: Q = 428,3 kPa

Permissible load at the deformation of 5%: Q = 656,5 kPa

type of load	load by soil weight									
height of protection (m)	0,30	0,40	0,50	0,60	0,70	0,80	0,90	1,00	1,10	
total load (kPa)	8,55	11,40	14,25	17,10	19,95	22,80	25,65	28,50	31,35	
type of load	road load class A									
height of protection (m)	0,30	0,40	0,50	0,60	0,70	0,80	0,90	1,00	1,10	
total load (kPa)	857,6	489,6	315,3	223,6	170,6	138,1	117,1	103,3	93,9	
type of load	road load class B									
height of protection (m)	0,30	0,40	0,50	0,60	0,70	0,80	0,90	1,00	1,10	
total load (kPa)	604,7	340,2	221,2	159,1	123,5	102,0	88,6	79,9	74,4	
type of load	drive load									
height of protection (m)	0,30	0,40	0,50	0,60	0,70	0,80	0,90	1,00	1,10	
total load (kPa)	297,4	170,4	113,8	84,9	68,8	59,6	54,3	51,4	50,1	
type of load	pavement and cycling track load									
height of protection (m)	0,30	0,40	0,50	0,60	0,70	0,80	0,90	1,00	1,10	
total load (kPa)	63,4	42,0	33,7	30,5	29,8	30,3	31,6	33,3	35,4	
type of load	tram load									
height of protection (m)	0,30	0,40	0,50	0,60	0,70	0,80	0,90	1,00	1,10	
total load (kPa)	365,6	211,1	141,8	106,1	86,3	74,9	68,4	64,8	63,1	
type of load	single rail load UIC 71 train									
height of protection (m)	0,8	1,0	1,5	2,0	2,5	3,0	3,5	4,0	4,5	5,0
total load (kPa)	137,0	105,4	85,7	90,2	98,3	107,9	118,4	129,6	141,4	153,7
type of load	double rail load UIC 71 train									
height of protection (m)	0,8	1,0	1,5	2,0	2,5	3,0	3,5	4,0	4,5	5,0
total load (kPa)	137,4	106,2	87,4	93,0	101,9	111,8	122,4	133,5	145,1	157,2

XXXX

Highlighting the cases, when ducts fail to meet the requirements or their use is on the limit of permissible load.

06050

- HDPE communication cable duct

Ring stiffness in accordance with ČSN EN ISO 9969 $S = 30,66 \text{ kPa}$

Permissible load at the deformation of 3%: $Q = 243,4 \text{ kPa}$

Permissible load at the deformation of 5%: $Q = 478,9 \text{ kPa}$

type of load	load by soil weight									
height of protection (m)	0,30	0,40	0,50	0,60	0,70	0,80	0,90	1,00	1,10	
total load (kPa)	8,55	11,40	14,25	17,10	19,95	22,80	25,65	28,50	31,35	
type of load	road load class A									
height of protection (m)	0,30	0,40	0,50	0,60	0,70	0,80	0,90	1,00	1,10	
total load (kPa)	857,6	489,6	315,3	223,6	170,6	138,1	117,1	103,3	93,9	
type of load	road load class B									
height of protection (m)	0,30	0,40	0,50	0,60	0,70	0,80	0,90	1,00	1,10	
total load (kPa)	604,7	340,2	221,2	159,1	123,5	102,0	88,6	79,9	74,4	
type of load	drive load									
height of protection (m)	0,30	0,40	0,50	0,60	0,70	0,80	0,90	1,00	1,10	
total load (kPa)	297,4	170,4	113,8	84,9	68,8	59,6	54,3	51,4	50,1	
type of load	pavement and cycling track load									
height of protection (m)	0,30	0,40	0,50	0,60	0,70	0,80	0,90	1,00	1,10	
total load (kPa)	63,4	42,0	33,7	30,5	29,8	30,3	31,6	33,3	35,4	
type of load	tram load									
height of protection (m)	0,30	0,40	0,50	0,60	0,70	0,80	0,90	1,00	1,10	
total load (kPa)	365,6	211,1	141,8	106,1	86,3	74,9	68,4	64,8	63,1	
type of load	single rail load UIC 71 train									
height of protection (m)	0,8	1,0	1,5	2,0	2,5	3,0	3,5	4,0	4,5	5,0
total load (kPa)	137,0	105,4	85,7	90,2	98,3	107,9	118,4	129,6	141,4	153,7
type of load	double rail load UIC 71 train									
height of protection (m)	0,8	1,0	1,5	2,0	2,5	3,0	3,5	4,0	4,5	5,0
total load (kPa)	137,4	106,2	87,4	93,0	101,9	111,8	122,4	133,5	145,1	157,2

XXXX

Highlighting the cases, when ducts fail to meet the requirements or their use is on the limit of permissible load.



06110/2

- divided cable duct KOPOHALF®

Ring stiffness in accordance with ČSN EN ISO 9969 S = 9,8 kPa
 Permissible load at the deformation of 3%: Q = 122,8 kPa
 Permissible load at the deformation of 5%: Q = 204,7 kPa

type of load	load by soil weight									
height of protection (m)	0,30	0,40	0,50	0,60	0,70	0,80	0,90	1,00	1,10	
total load (kPa)	8,55	11,40	14,25	17,10	19,95	22,80	25,65	28,50	31,35	
type of load	road load class A									
height of protection (m)	0,30	0,40	0,50	0,60	0,70	0,80	0,90	1,00	1,10	
total load (kPa)	857,6	489,6	315,3	223,6	170,6	138,1	117,1	103,3	93,9	
type of load	road load class B									
height of protection (m)	0,30	0,40	0,50	0,60	0,70	0,80	0,90	1,00	1,10	
total load (kPa)	604,7	340,2	221,2	159,1	123,5	102,0	88,6	79,9	74,4	
type of load	drive load									
height of protection (m)	0,30	0,40	0,50	0,60	0,70	0,80	0,90	1,00	1,10	
total load (kPa)	297,4	170,4	113,8	84,9	68,8	59,6	54,3	51,4	50,1	
type of load	pavement and cycling track load									
height of protection (m)	0,30	0,40	0,50	0,60	0,70	0,80	0,90	1,00	1,10	
total load (kPa)	63,4	42,0	33,7	30,5	29,8	30,3	31,6	33,3	35,4	
type of load	tram load									
height of protection (m)	0,30	0,40	0,50	0,60	0,70	0,80	0,90	1,00	1,10	
total load (kPa)	365,6	211,1	141,8	106,1	86,3	74,9	68,4	64,8	63,1	
type of load	single rail load UIC 71 train									
height of protection (m)	0,8	1,0	1,5	2,0	2,5	3,0	3,5	4,0	4,5	5,0
total load (kPa)	137,0	105,4	85,7	90,2	98,3	107,9	118,4	129,6	141,4	153,7
type of load	double rail load UIC 71 train									
height of protection (m)	0,8	1,0	1,5	2,0	2,5	3,0	3,5	4,0	4,5	5,0
total load (kPa)	137,4	106,2	87,4	93,0	101,9	111,8	122,4	133,5	145,1	157,2

XXXX

Highlighting the cases, when ducts fail to meet the requirements or their use is on the limit of permissible load.

06110P/2

- divided cable duct KOPOHALF®

Ring stiffness in accordance with ČSN EN ISO 9969 S = 91,3 kPa

Permissible load at the deformation of 3%: Q = 594,0 kPa

Permissible load at the deformation of 5%: Q = 990,0 kPa

type of load	load by soil weight									
height of protection (m)	0,30	0,40	0,50	0,60	0,70	0,80	0,90	1,00	1,10	
total load (kPa)	8,55	11,40	14,25	17,10	19,95	22,80	25,65	28,50	31,35	
type of load	road load class A									
height of protection (m)	0,30	0,40	0,50	0,60	0,70	0,80	0,90	1,00	1,10	
total load (kPa)	857,6	489,6	315,3	223,6	170,6	138,1	117,1	103,3	93,9	
type of load	road load class B									
height of protection (m)	0,30	0,40	0,50	0,60	0,70	0,80	0,90	1,00	1,10	
total load (kPa)	604,7	340,2	221,2	159,1	123,5	102,0	88,6	79,9	74,4	
type of load	drive load									
height of protection (m)	0,30	0,40	0,50	0,60	0,70	0,80	0,90	1,00	1,10	
total load (kPa)	297,4	170,4	113,8	84,9	68,8	59,6	54,3	51,4	50,1	
type of load	pavement and cycling track load									
height of protection (m)	0,30	0,40	0,50	0,60	0,70	0,80	0,90	1,00	1,10	
total load (kPa)	63,4	42,0	33,7	30,5	29,8	30,3	31,6	33,3	35,4	
type of load	tram load									
height of protection (m)	0,30	0,40	0,50	0,60	0,70	0,80	0,90	1,00	1,10	
total load (kPa)	365,6	211,1	141,8	106,1	86,3	74,9	68,4	64,8	63,1	
type of load	single rail load UIC 71 train									
height of protection (m)	0,8	1,0	1,5	2,0	2,5	3,0	3,5	4,0	4,5	5,0
total load (kPa)	137,0	105,4	85,7	90,2	98,3	107,9	118,4	129,6	141,4	153,7
type of load	double rail load UIC 71 train									
height of protection (m)	0,8	1,0	1,5	2,0	2,5	3,0	3,5	4,0	4,5	5,0
total load (kPa)	137,4	106,2	87,4	93,0	101,9	111,8	122,4	133,5	145,1	157,2

XXXX

Highlighting the cases, when ducts fail to meet the requirements or their use is on the limit of permissible load.



06160/2

- divided cable duct KOPOHALF®

Ring stiffness in accordance with ČSN EN ISO 9969 S = 15,0 kPa
 Permissible load at the deformation of 3%: Q = 152,0 kPa
 Permissible load at the deformation of 5%: Q = 254,8 kPa

type of load	load by soil weight									
height of protection (m)	0,30	0,40	0,50	0,60	0,70	0,80	0,90	1,00	1,10	
total load (kPa)	8,55	11,40	14,25	17,10	19,95	22,80	25,65	28,50	31,35	
type of load	road load class A									
height of protection (m)	0,30	0,40	0,50	0,60	0,70	0,80	0,90	1,00	1,10	
total load (kPa)	857,6	489,6	315,3	223,6	170,6	138,1	117,1	103,3	93,9	
type of load	road load class B									
height of protection (m)	0,30	0,40	0,50	0,60	0,70	0,80	0,90	1,00	1,10	
total load (kPa)	604,7	340,2	221,2	159,1	123,5	102,0	88,6	79,9	74,4	
type of load	drive load									
height of protection (m)	0,30	0,40	0,50	0,60	0,70	0,80	0,90	1,00	1,10	
total load (kPa)	297,4	170,4	113,8	84,9	68,8	59,6	54,3	51,4	50,1	
type of load	pavement and cycling track load									
height of protection (m)	0,30	0,40	0,50	0,60	0,70	0,80	0,90	1,00	1,10	
total load (kPa)	63,4	42,0	33,7	30,5	29,8	30,3	31,6	33,3	35,4	
type of load	tram load									
height of protection (m)	0,30	0,40	0,50	0,60	0,70	0,80	0,90	1,00	1,10	
total load (kPa)	365,6	211,1	141,8	106,1	86,3	74,9	68,4	64,8	63,1	
type of load	single rail load UIC 71 train									
height of protection (m)	0,8	1,0	1,5	2,0	2,5	3,0	3,5	4,0	4,5	5,0
total load (kPa)	137,0	105,4	85,7	90,2	98,3	107,9	118,4	129,6	141,4	153,7
type of load	double rail load UIC 71 train									
height of protection (m)	0,8	1,0	1,5	2,0	2,5	3,0	3,5	4,0	4,5	5,0
total load (kPa)	137,4	106,2	87,4	93,0	101,9	111,8	122,4	133,5	145,1	157,2

XXXX

Highlighting the cases, when ducts fail to meet the requirements or their use is on the limit of permissible load.

KOPOKAN 1

- inground channel

Ring stiffness in accordance with ČSN EN ISO 9969 S = 80,53 kPa

Permissible load at the deformation of 3%: Q = 337,4 kPa

Permissible load at the deformation of 5%: Q = 845,7 kPa

type of load	load by soil weight									
height of protection (m)	0,30	0,40	0,50	0,60	0,70	0,80	0,90	1,00	1,10	
total load (kPa)	8,55	11,40	14,25	17,10	19,95	22,80	25,65	28,50	31,35	
type of load	road load class A									
height of protection (m)	0,30	0,40	0,50	0,60	0,70	0,80	0,90	1,00	1,10	
total load (kPa)	857,6	489,6	315,3	223,6	170,6	138,1	117,1	103,3	93,9	
type of load	road load class B									
height of protection (m)	0,30	0,40	0,50	0,60	0,70	0,80	0,90	1,00	1,10	
total load (kPa)	604,7	340,2	221,2	159,1	123,5	102,0	88,6	79,9	74,4	
type of load	drive load									
height of protection (m)	0,30	0,40	0,50	0,60	0,70	0,80	0,90	1,00	1,10	
total load (kPa)	297,4	170,4	113,8	84,9	68,8	59,6	54,3	51,4	50,1	
type of load	pavement and cycling track load									
height of protection (m)	0,30	0,40	0,50	0,60	0,70	0,80	0,90	1,00	1,10	
total load (kPa)	63,4	42,0	33,7	30,5	29,8	30,3	31,6	33,3	35,4	
type of load	tram load									
height of protection (m)	0,30	0,40	0,50	0,60	0,70	0,80	0,90	1,00	1,10	
total load (kPa)	365,6	211,1	141,8	106,1	86,3	74,9	68,4	64,8	63,1	
type of load	single rail load UIC 71 train									
height of protection (m)	0,8	1,0	1,5	2,0	2,5	3,0	3,5	4,0	4,5	5,0
total load (kPa)	137,0	105,4	85,7	90,2	98,3	107,9	118,4	129,6	141,4	153,7
type of load	double rail load UIC 71 train									
height of protection (m)	0,8	1,0	1,5	2,0	2,5	3,0	3,5	4,0	4,5	5,0
total load (kPa)	137,4	106,2	87,4	93,0	101,9	111,8	122,4	133,5	145,1	157,2

XXXX

Highlighting the cases, when channels fail to meet the requirements or their use is on the limit of permissible load.



KOPOKAN 2

- inground channel

Ring stiffness in accordance with ČSN EN ISO 9969 S = 165 kPa

Permissible load at the deformation of 3%: Q = 387,1 kPa

Permissible load at the deformation of 5%: Q = 961,3 kPa

type of load	load by soil weight									
height of protection (m)	0,30	0,40	0,50	0,60	0,70	0,80	0,90	1,00	1,10	
total load (kPa)	8,55	11,40	14,25	17,10	19,95	22,80	25,65	28,50	31,35	
type of load	road load class A									
height of protection (m)	0,30	0,40	0,50	0,60	0,70	0,80	0,90	1,00	1,10	
total load (kPa)	857,6	489,6	315,3	223,6	170,6	138,1	117,1	103,3	93,9	
type of load	road load class B									
height of protection (m)	0,30	0,40	0,50	0,60	0,70	0,80	0,90	1,00	1,10	
total load (kPa)	604,7	340,2	221,2	159,1	123,5	102,0	88,6	79,9	74,4	
type of load	drive load									
height of protection (m)	0,30	0,40	0,50	0,60	0,70	0,80	0,90	1,00	1,10	
total load (kPa)	297,4	170,4	113,8	84,9	68,8	59,6	54,3	51,4	50,1	
type of load	pavement and cycling track load									
height of protection (m)	0,30	0,40	0,50	0,60	0,70	0,80	0,90	1,00	1,10	
total load (kPa)	63,4	42,0	33,7	30,5	29,8	30,3	31,6	33,3	35,4	
type of load	tram load									
height of protection (m)	0,30	0,40	0,50	0,60	0,70	0,80	0,90	1,00	1,10	
total load (kPa)	365,6	211,1	141,8	106,1	86,3	74,9	68,4	64,8	63,1	
type of load	single rail load UIC 71 train									
height of protection (m)	0,8	1,0	1,5	2,0	2,5	3,0	3,5	4,0	4,5	5,0
total load (kPa)	137,0	105,4	85,7	90,2	98,3	107,9	118,4	129,6	141,4	153,7
type of load	double rail load UIC 71 train									
height of protection (m)	0,8	1,0	1,5	2,0	2,5	3,0	3,5	4,0	4,5	5,0
total load (kPa)	137,4	106,2	87,4	93,0	101,9	111,8	122,4	133,5	145,1	157,2

XXXX

Highlighting the cases, when channels fail to meet the requirements or their use is on the limit of permissible load.

KOPOKAN 3

- inground channel

Ring stiffness in accordance with ČSN EN ISO 9969 S = 199 kPa
 Permissible load at the deformation of 3%: Q = 665,3 kPa
 Permissible load at the deformation of 5%: Q = 1807,6 kPa

type of load	load by soil weight									
height of protection (m)	0,30	0,40	0,50	0,60	0,70	0,80	0,90	1,00	1,10	
total load (kPa)	8,55	11,40	14,25	17,10	19,95	22,80	25,65	28,50	31,35	
type of load	road load class A									
height of protection (m)	0,30	0,40	0,50	0,60	0,70	0,80	0,90	1,00	1,10	
total load (kPa)	857,6	489,6	315,3	223,6	170,6	138,1	117,1	103,3	93,9	
type of load	road load class B									
height of protection (m)	0,30	0,40	0,50	0,60	0,70	0,80	0,90	1,00	1,10	
total load (kPa)	604,7	340,2	221,2	159,1	123,5	102,0	88,6	79,9	74,4	
type of load	drive load									
height of protection (m)	0,30	0,40	0,50	0,60	0,70	0,80	0,90	1,00	1,10	
total load (kPa)	297,4	170,4	113,8	84,9	68,8	59,6	54,3	51,4	50,1	
type of load	pavement and cycling track load									
height of protection (m)	0,30	0,40	0,50	0,60	0,70	0,80	0,90	1,00	1,10	
total load (kPa)	63,4	42,0	33,7	30,5	29,8	30,3	31,6	33,3	35,4	
type of load	tram load									
height of protection (m)	0,30	0,40	0,50	0,60	0,70	0,80	0,90	1,00	1,10	
total load (kPa)	365,6	211,1	141,8	106,1	86,3	74,9	68,4	64,8	63,1	
type of load	single rail load UIC 71 train									
height of protection (m)	0,8	1,0	1,5	2,0	2,5	3,0	3,5	4,0	4,5	5,0
total load (kPa)	137,0	105,4	85,7	90,2	98,3	107,9	118,4	129,6	141,4	153,7
type of load	double rail load UIC 71 train									
height of protection (m)	0,8	1,0	1,5	2,0	2,5	3,0	3,5	4,0	4,5	5,0
total load (kPa)	137,4	106,2	87,4	93,0	101,9	111,8	122,4	133,5	145,1	157,2

XXXX

Highlighting the cases, when channels fail to meet the requirements or their use is on the limit of permissible load.

KOPOKAN 4

- inground channel

Ring stiffness in accordance with ČSN EN ISO 9969 $S = 284 \text{ kPa}$
 Permissible load at the deformation of 3%: $Q = 652,6 \text{ kPa}$
 Permissible load at the deformation of 5%: $Q = 1612,9 \text{ kPa}$

type of load	load by soil weight									
height of protection (m)	0,30	0,40	0,50	0,60	0,70	0,80	0,90	1,00	1,10	
total load (kPa)	8,55	11,40	14,25	17,10	19,95	22,80	25,65	28,50	31,35	
type of load	road load class A									
height of protection (m)	0,30	0,40	0,50	0,60	0,70	0,80	0,90	1,00	1,10	
total load (kPa)	857,6	489,6	315,3	223,6	170,6	138,1	117,1	103,3	93,9	
type of load	road load class B									
height of protection (m)	0,30	0,40	0,50	0,60	0,70	0,80	0,90	1,00	1,10	
total load (kPa)	604,7	340,2	221,2	159,1	123,5	102,0	88,6	79,9	74,4	
type of load	drive load									
height of protection (m)	0,30	0,40	0,50	0,60	0,70	0,80	0,90	1,00	1,10	
total load (kPa)	297,4	170,4	113,8	84,9	68,8	59,6	54,3	51,4	50,1	
type of load	pavement and cycling track load									
height of protection (m)	0,30	0,40	0,50	0,60	0,70	0,80	0,90	1,00	1,10	
total load (kPa)	63,4	42,0	33,7	30,5	29,8	30,3	31,6	33,3	35,4	
type of load	tram load									
height of protection (m)	0,30	0,40	0,50	0,60	0,70	0,80	0,90	1,00	1,10	
total load (kPa)	365,6	211,1	141,8	106,1	86,3	74,9	68,4	64,8	63,1	
type of load	single rail load UIC 71 train									
height of protection (m)	0,8	1,0	1,5	2,0	2,5	3,0	3,5	4,0	4,5	5,0
total load (kPa)	137,0	105,4	85,7	90,2	98,3	107,9	118,4	129,6	141,4	153,7
type of load	double rail load UIC 71 train									
height of protection (m)	0,8	1,0	1,5	2,0	2,5	3,0	3,5	4,0	4,5	5,0
total load (kPa)	137,4	106,2	87,4	93,0	101,9	111,8	122,4	133,5	145,1	157,2

XXXX

Highlighting the cases, when channels fail to meet the requirements or their use is on the limit of permissible load.

1. JOINING PROTECTIVE PIPES

- ▶ The protective pipes are connected using the 02xxx_FA coupling. The coupling is a part of every coil (KOPOFLEX®) or stick (KOPODUR®).
- ▶ Insert the end of the protective pipe as far as it goes into the coupling. This connection guarantees IP 40 protection.
- ▶ Two 16xxx_FB sealing rings must be used for the watertight connection of the protective pipes.
- ▶ Lubricate the sealing ring with a lubricant and insert it into the second groove at the end of the protective pipe. We will do the same at the end of the second one.
- ▶ Insert the end of the protective pipe with the sealing ring as far as it goes into the coupling.
- ▶ This connection guarantees IP 67 protection. We offer sealing rings up to a diameter of 110 mm.

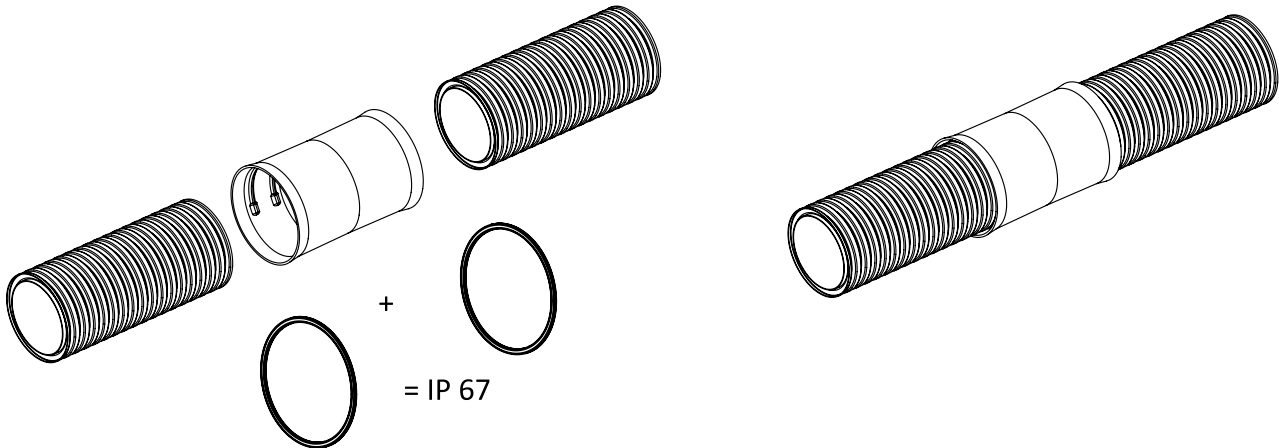

2. LAYING OF PROTECTIVE PIPES

It is recommended to cover KOPOFLEX® and KOPODUR® protectors with soil with grains up to a size of 50 mm in a volume of max. 10% in the soil.

Detailed conditions are set by the ČSN EN 1610 standard, which replaces the no longer valid ČSN 73 30 50. We present the description of the soil according to the already invalid standard, because it well describes the character of the soil:

- a) cohesive, soft consistency. e.g. topsoil, clay, sandy clay, loamy sand
- b) incoherent, loose grains up to 20 mm with grains over 20 to 50 mm in a volume of up to 10% of the total volume of 1st class soil, e.g. sand, sand with gravel, sandy gravel, small and medium gravel, or gravel with stones
- c) construction waste and weighing of a similar nature as soils included in the 1st class.

- ▶ Sprinkle the protective pipe on both sides, compactable with soil without stones, in layers of max. 30 cm. The guards must not be pushed to the sides during the compaction.
- ▶ For multi-layer laying in the excavation, we place each layer of protectors separately (fill and compact), only then can we lay another layer.
- ▶ When concreting, we pay attention to the watertight connection of the protective pipes (using sealing rings inserted into the second groove) and secure the protectors against buoyancy! We choose such aids to prevent the damage of the protective pipe.



3. SPACERS

- ▶ In case of a multi-layer pipe installation, we install spacers for fixing the pipes.
- ▶ When using the spacers, we have to use spacers up to a maximum of 1.5 m.
- ▶ When we use spacers, we have to use a sand bed and cover all the layers of the protective pipes with sand in order to compact the layers.
- ▶ There must be no air pockets between the individual layers, otherwise the protective pipes would be deformed during the compaction.
- ▶ Spacers can be connected horizontally. In the vertical direction, the spacers cannot be connected, but we solve this by moving the spacers by about 0.5 m and then installing another layer of protectors - it is always necessary to cover the protectors with sand.

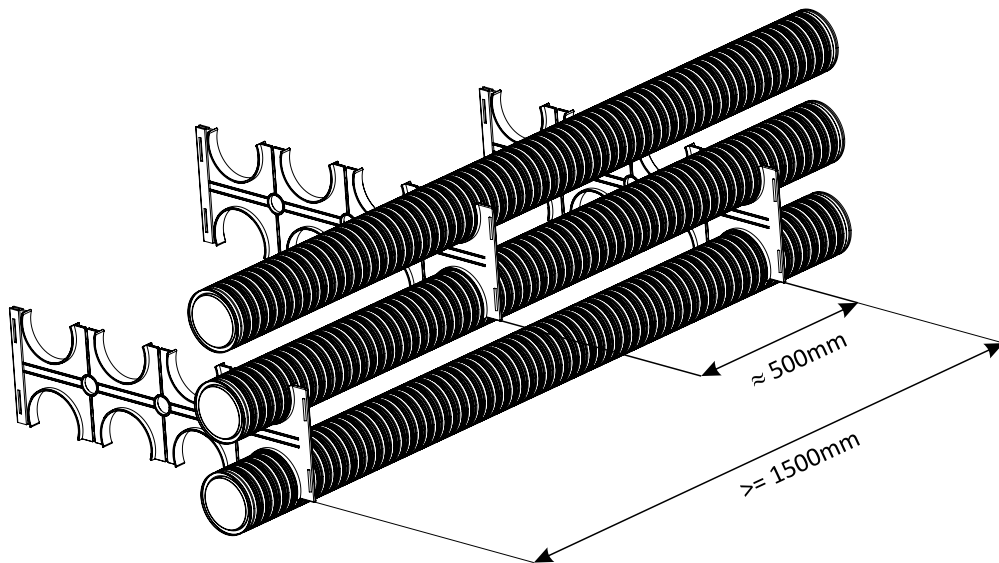

4. PLUGS

- ▶ The plugs are intended for blinding backup lines or for temporary blinding of guards during installation.

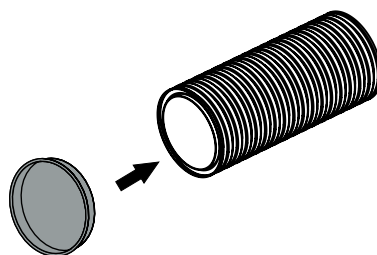

5. STRETCHING STRING

- ▶ The supplied stretching blue string in the KOPOFLEX® protective pipe is used to pull in the wire, resp. cable of the retracted cable. Before laying the protective pipes, always loosen the end of the string attached to the protector. If we do not need a stretching string, we will pull it out of the protective pipe before its assembly.

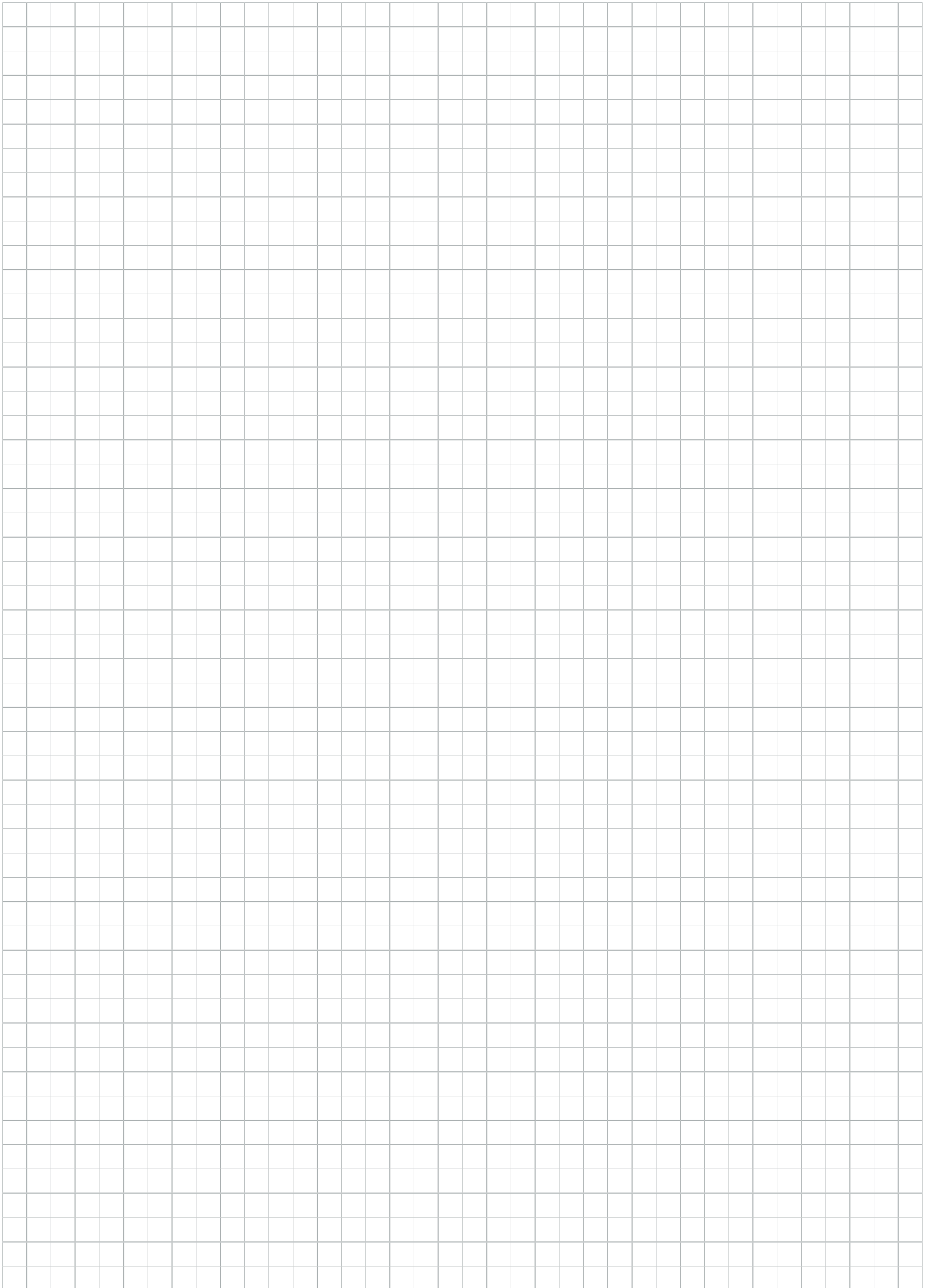

www.kopos.com



KOPOS KOLÍN a.s.
ABOUT US



KOPOS KOLÍN a.s.

Havlíčková 432
280 02 Kolín IV
Česká republika

tel.: +420 321 730 111
e-mail: kopos@kopos.cz
www.kopos.com

www.kopos.com

